

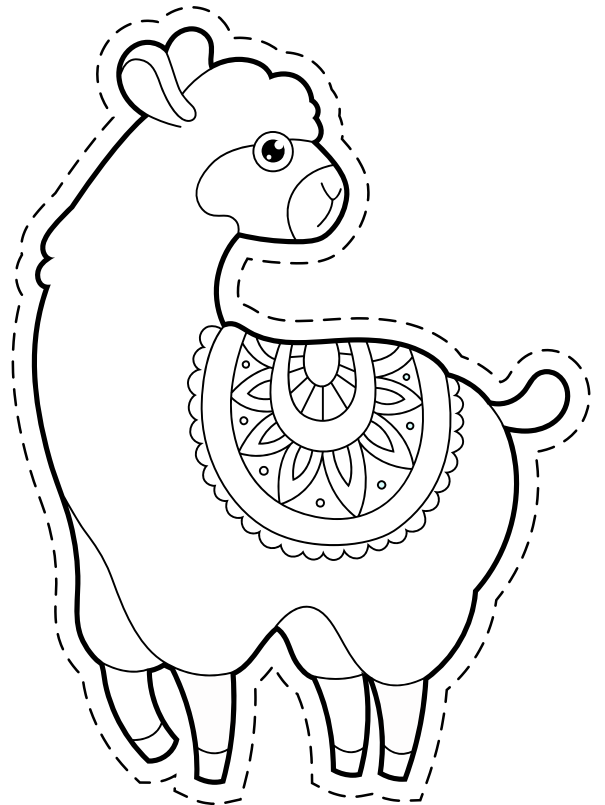

Games

Color the llamas
and cut them out!

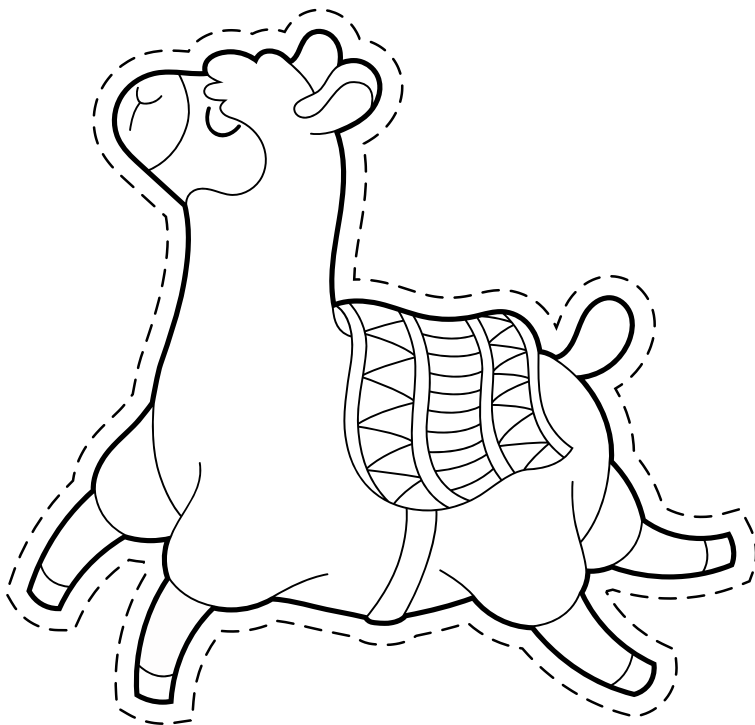
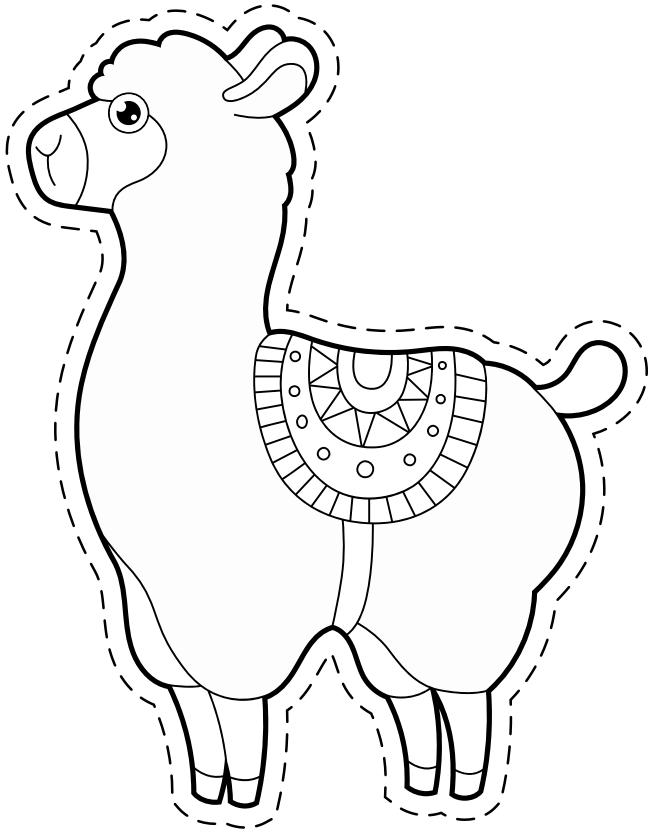

Color the hearts, cut them out, and hang them in your window for all to see!

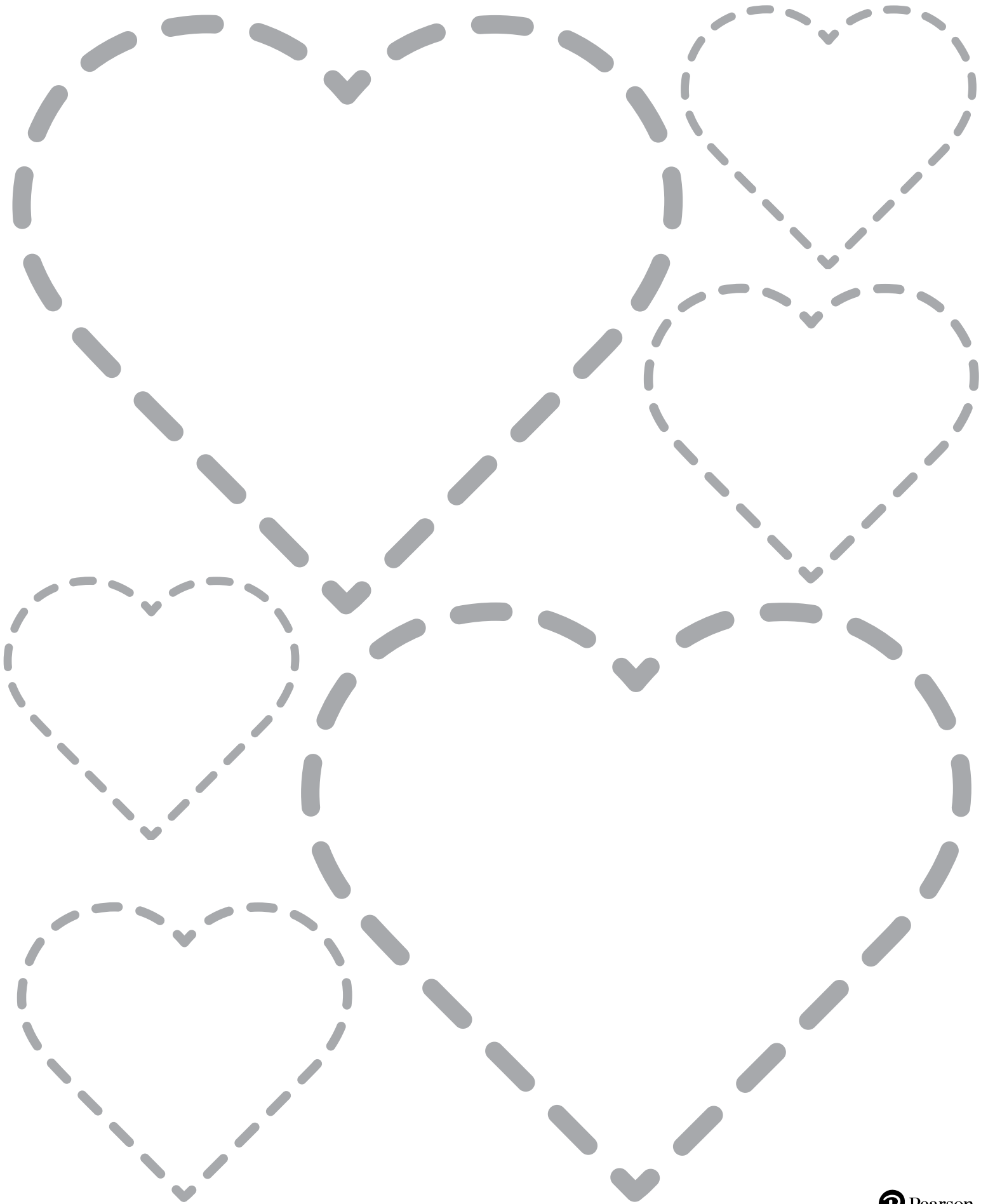

BUNNY BOOKMARK

COLOR PRINT and CUT OUT



cut on the dashed line

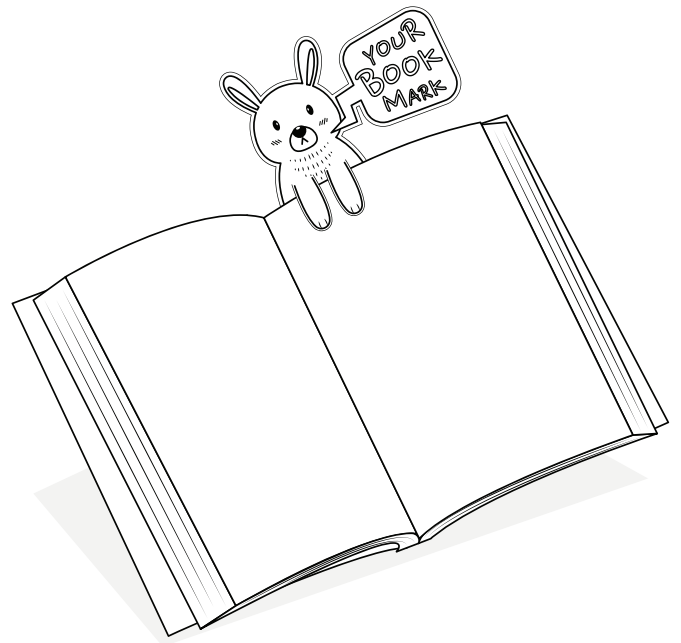

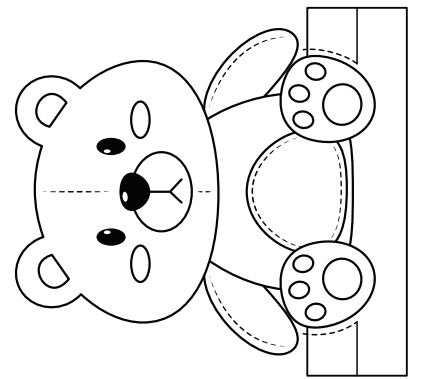
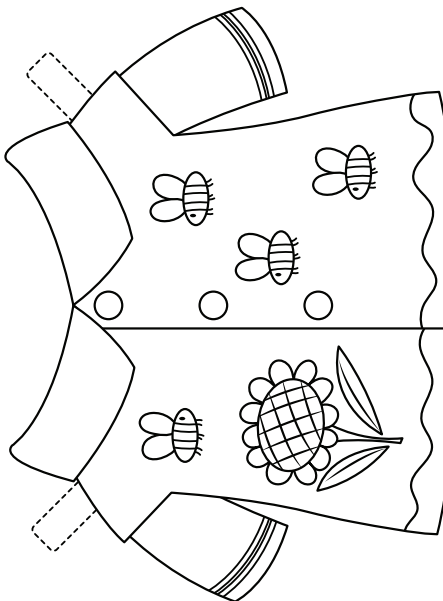
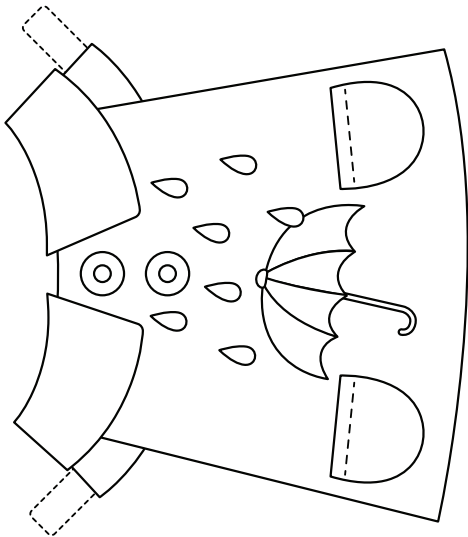
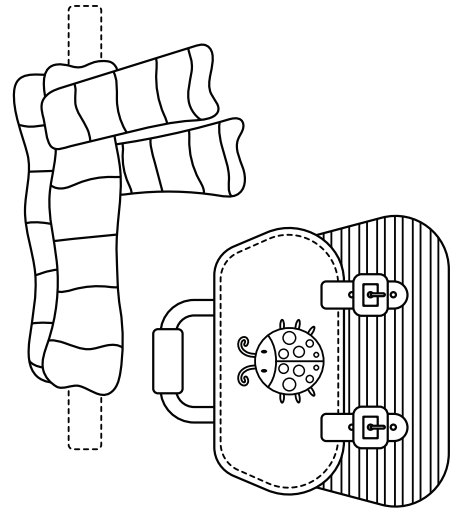
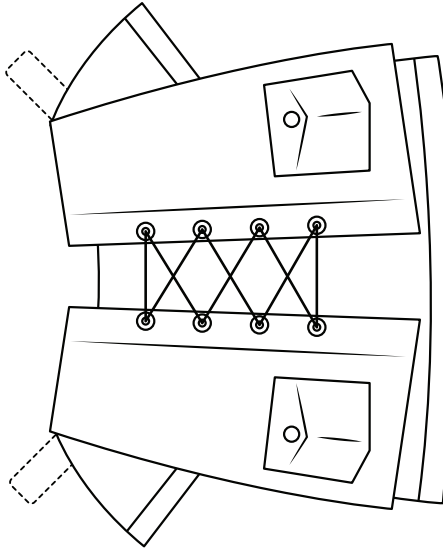
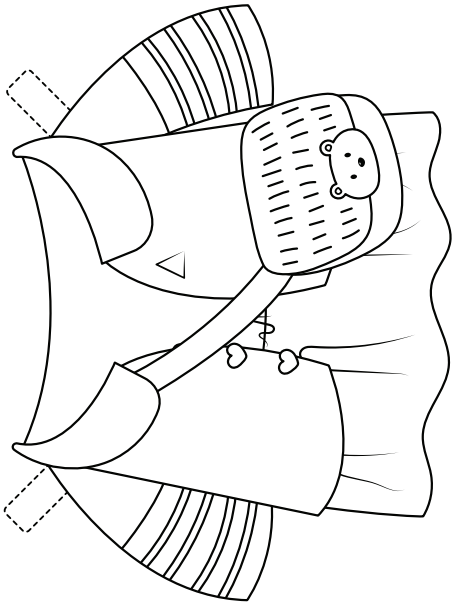
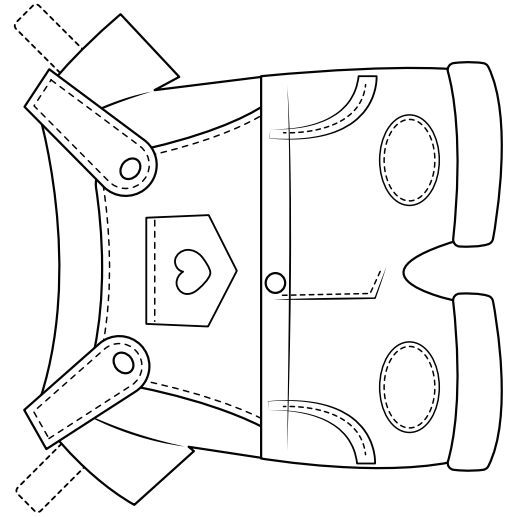
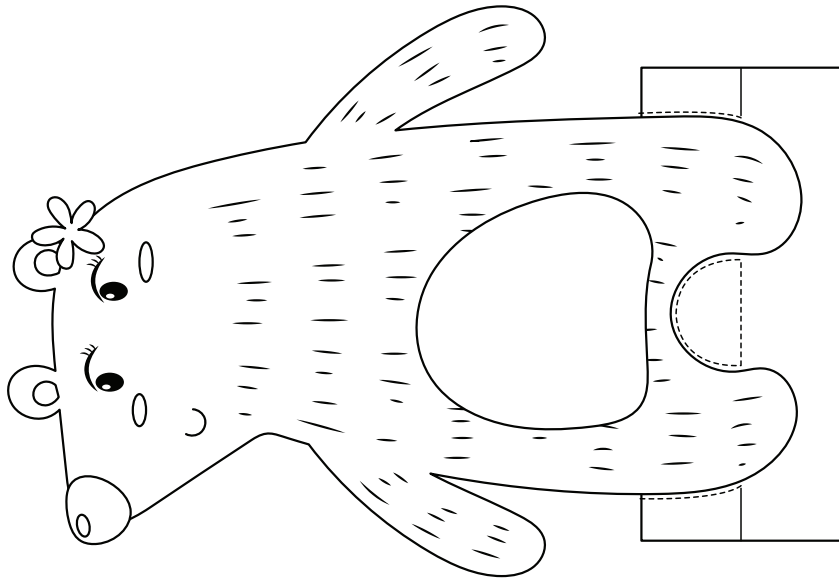

Cut & Glue!
Play

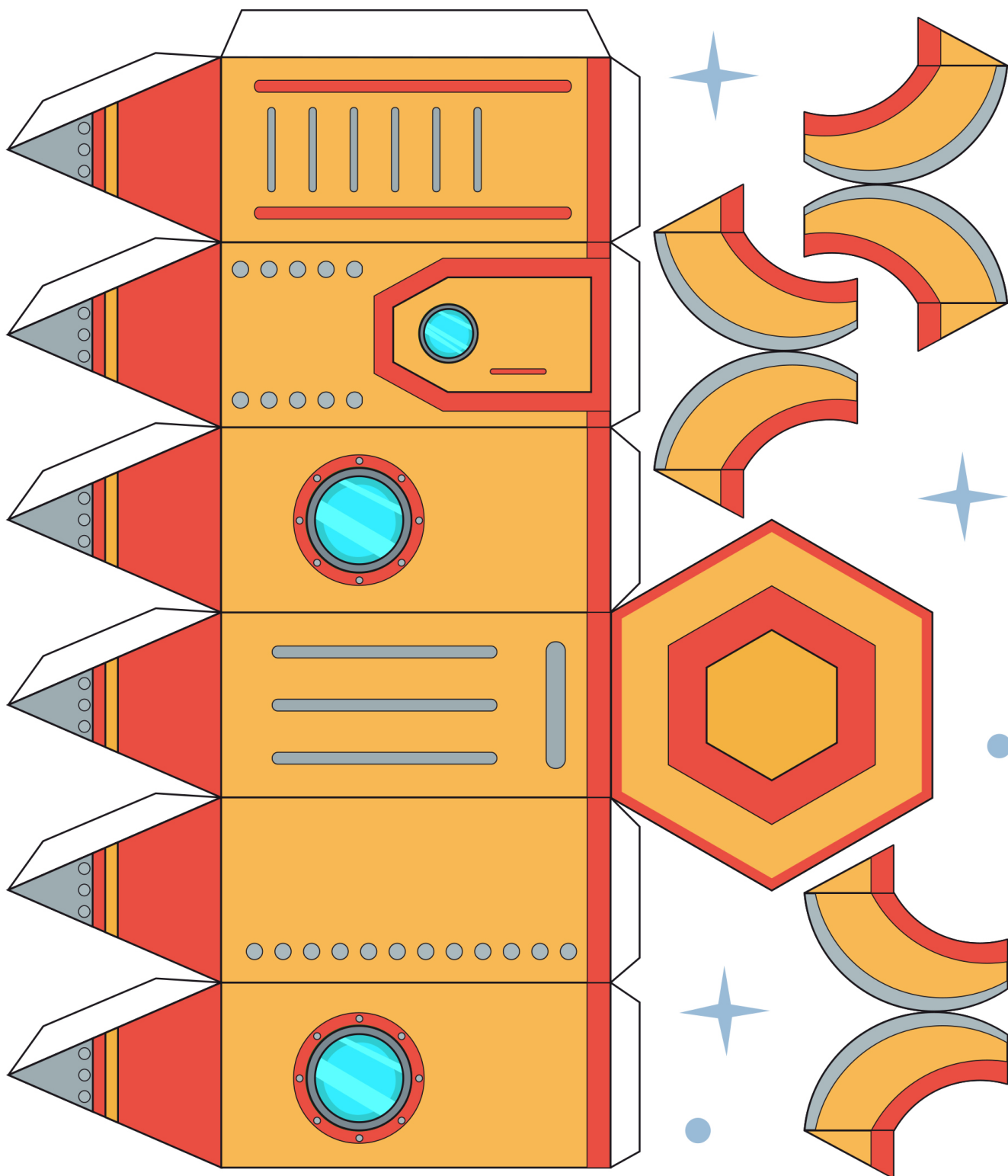
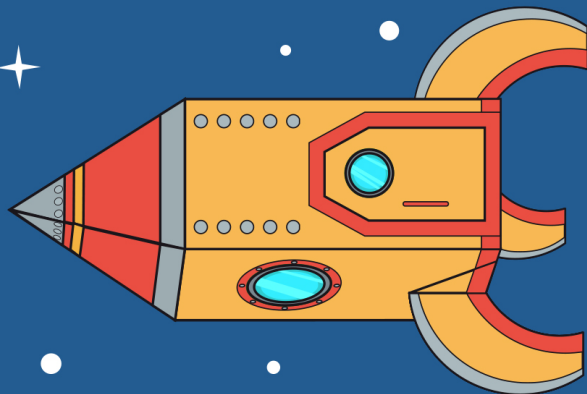

HOW TO DRAW A BUNNY

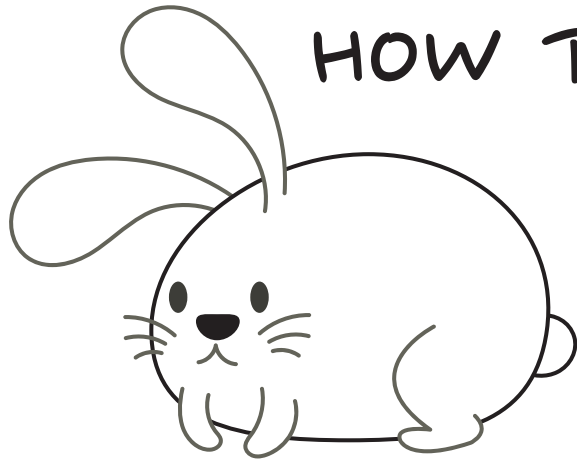

1.

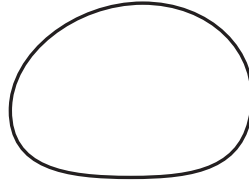

2.

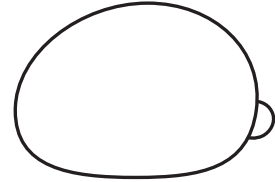

3.

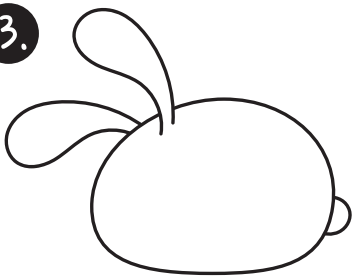

4.

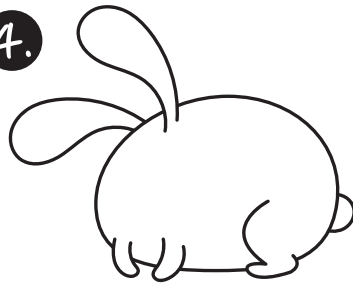

5.



HOW TO DRAW A SPIDER

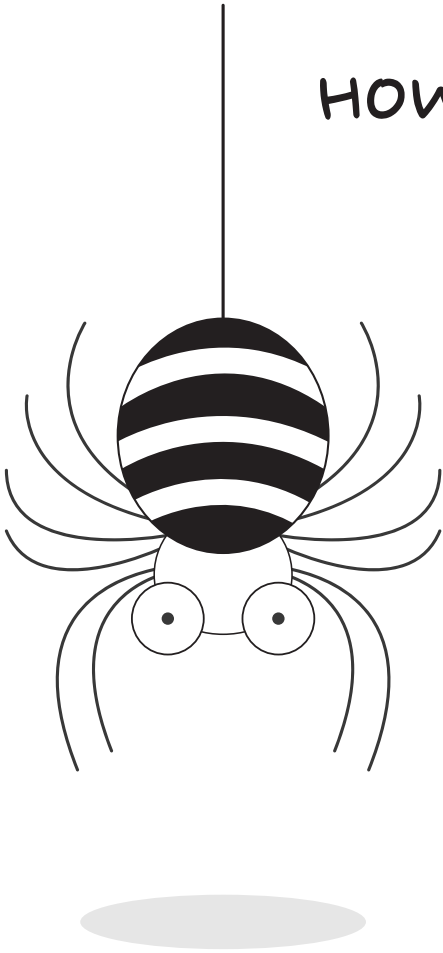

1. BODY

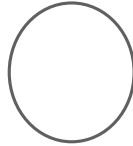

2. HEAD

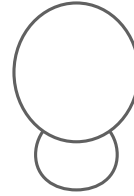

3. EYES

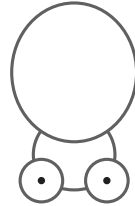

4. LEGS

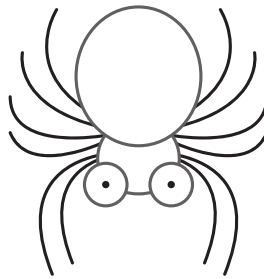

5. DETAILS



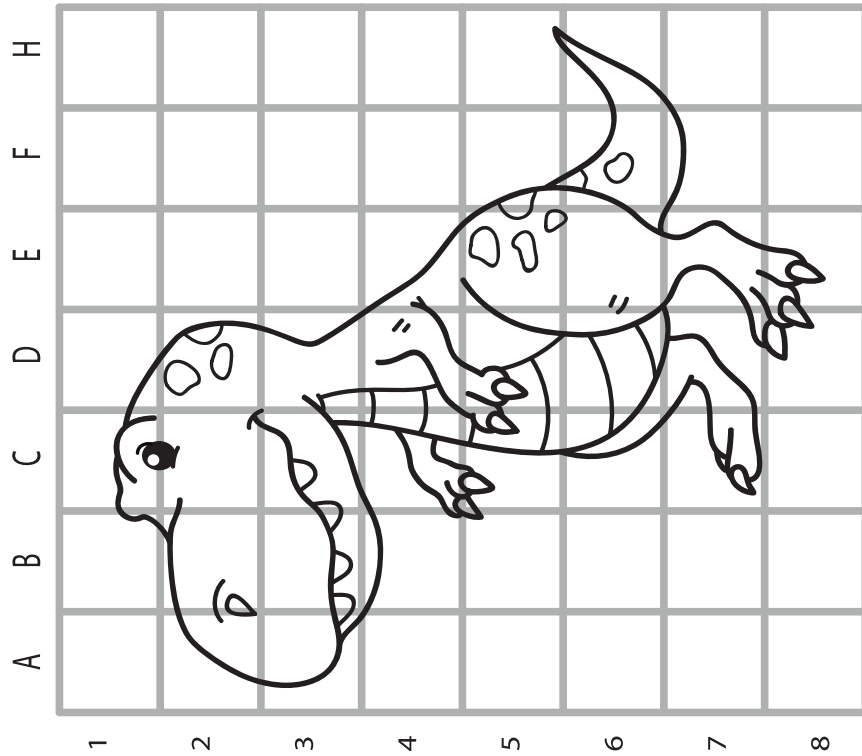
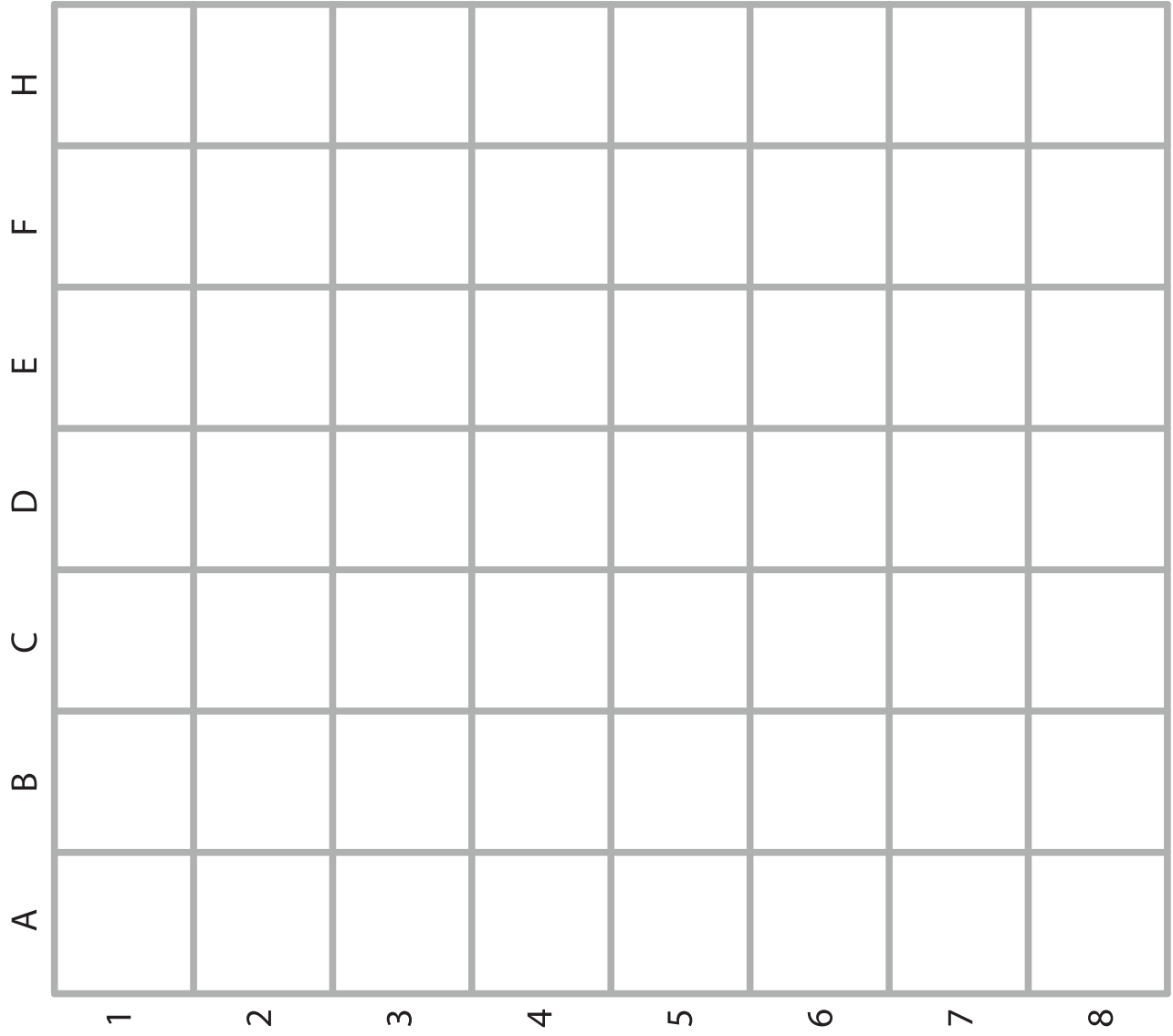

Copy the picture
using the grid

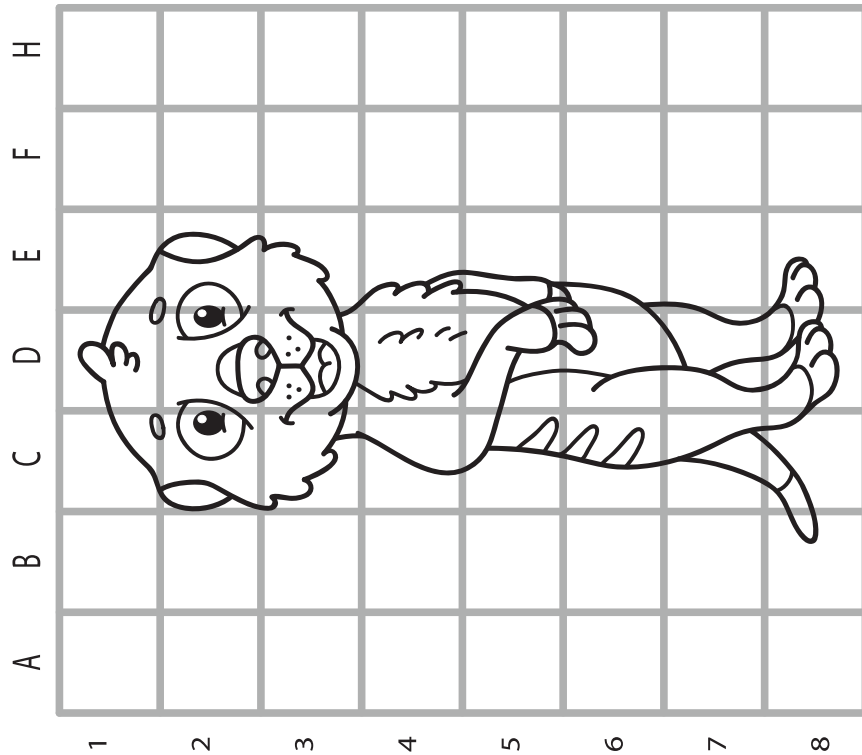
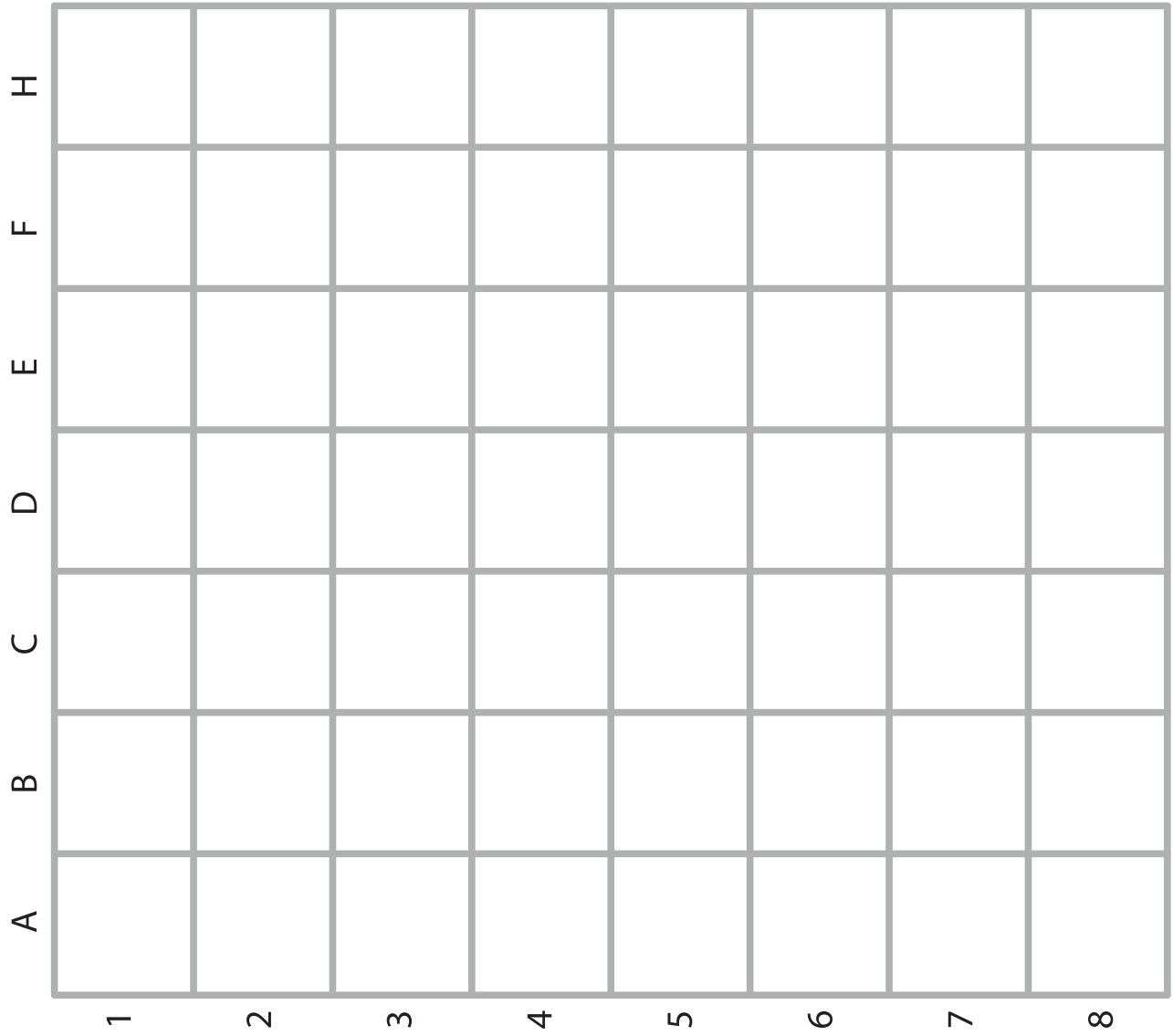

Copy the picture
using the grid



Flower

Ant

Puddle

Cloud

Bee

Spider web

Butterfly

Worm

Squirrel

Bird

Grass

Feather

Ladybug

Leaf

Pine cone

Nature Word Search

L	A	H	E	T	O	J	P	K	W
I	C	R	E	S	C	E	N	T	I
F	R	I	D	S	Y	R	I	C	N
C	L	O	U	D	S	A	M	J	D
T	I	Y	K	G	Y	I	E	T	A
A	L	I	G	H	T	N	I	N	G
S	H	A	S	I	L	B	H	T	I
N	E	F	O	G	K	O	E	S	D
O	R	A	I	N	A	W	E	U	S
W	Y	S	T	A	R	A	L	N	Y

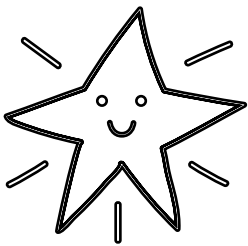
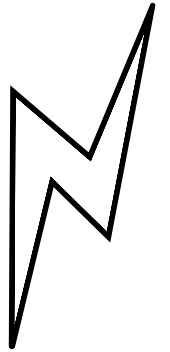
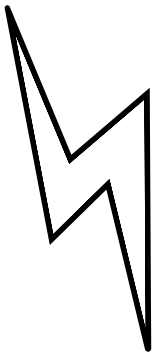

snow
fog
rain
star
sun

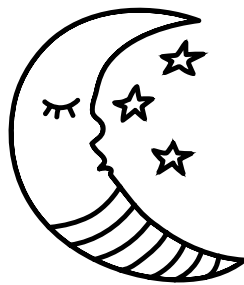

lightning
rainbow
wind
crescent
clouds

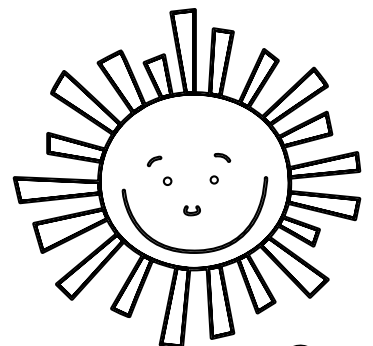
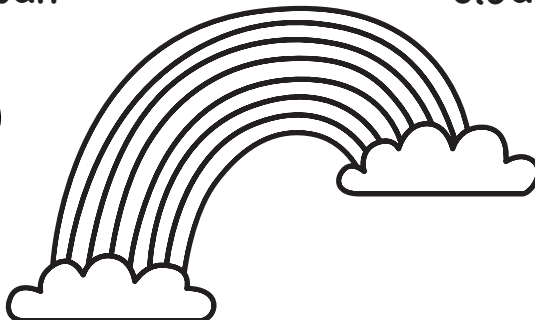
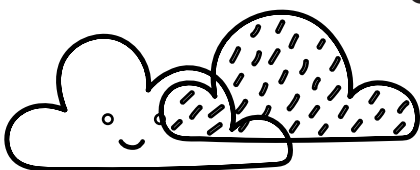
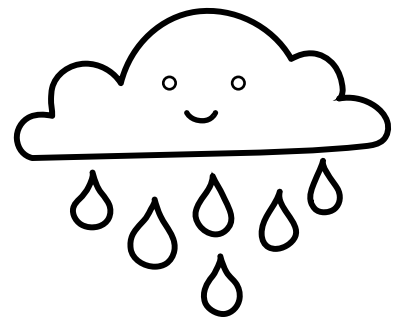

Sports Word Search

a	x	x	v	r	i	t	e	n	n	i	s	b	r	f	i	g
n	h	q	m	f	o	o	t	b	a	l	l	a	u	m	w	y
s	g	o	l	f	j						i	s	j	g	h	i
o	d	j	g	c	o						c	k	h	r	i	o
c	g	s	o	h	l						p	e	h	u	p	s
c	h	p	i	a	u						j	t	o	g	q	q
e	a	u	d	q	v						g	b	c	b	c	u
r	y	v	o	l	l	e	y	b	a	l	l	a	k	y	a	a
h	a	n	d	b	a	l	l	x	v	p	d	l	e	y	c	s
e	b	a	s	e	b	a	l	l	p	y	l	l	y	d	o	h

baseball

handball

squash

basketball

hockey

tennis

football

rugby

volleyball

golf

soccer

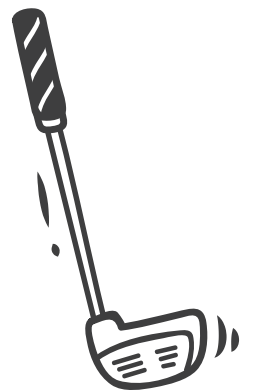
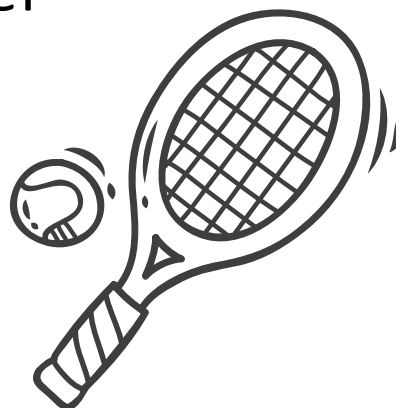
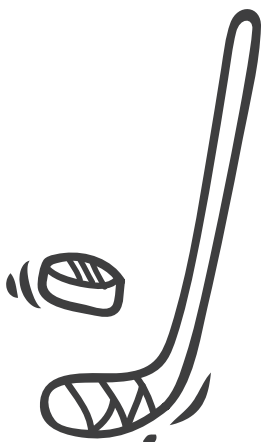

FIND THE WORDS

T Y P I S T A R T I S T
R U N E D I T O R K C R
A V R U I K B P Z D H A
N T W N R E A O C R E I
S E E E S K E A I M N
L A L M C R E T R V I E
A C D C T I R E P E S R
T H E H O N N W E R T J
O E R E R A T A N N N B
R R U F E H U I T A C U
S P I L O T T T E N O Y
D O C X V V O E R N O E
F L A W Y E R R M Y K R

ARTIST	DIRECTOR	TRAINER
BAKER	DRIVER	TRANSLATOR
BUYER	EDITOR	TURNER
CARPENTER	LAWYER	TUTOR
CHEF	NANNY	TYPIST
CHEMIST	NURSE	WAITER
CLEANER	PILOT	WELDER
CLERK	POET	
COOK	TEACHER	

Help the dino mom find her baby!

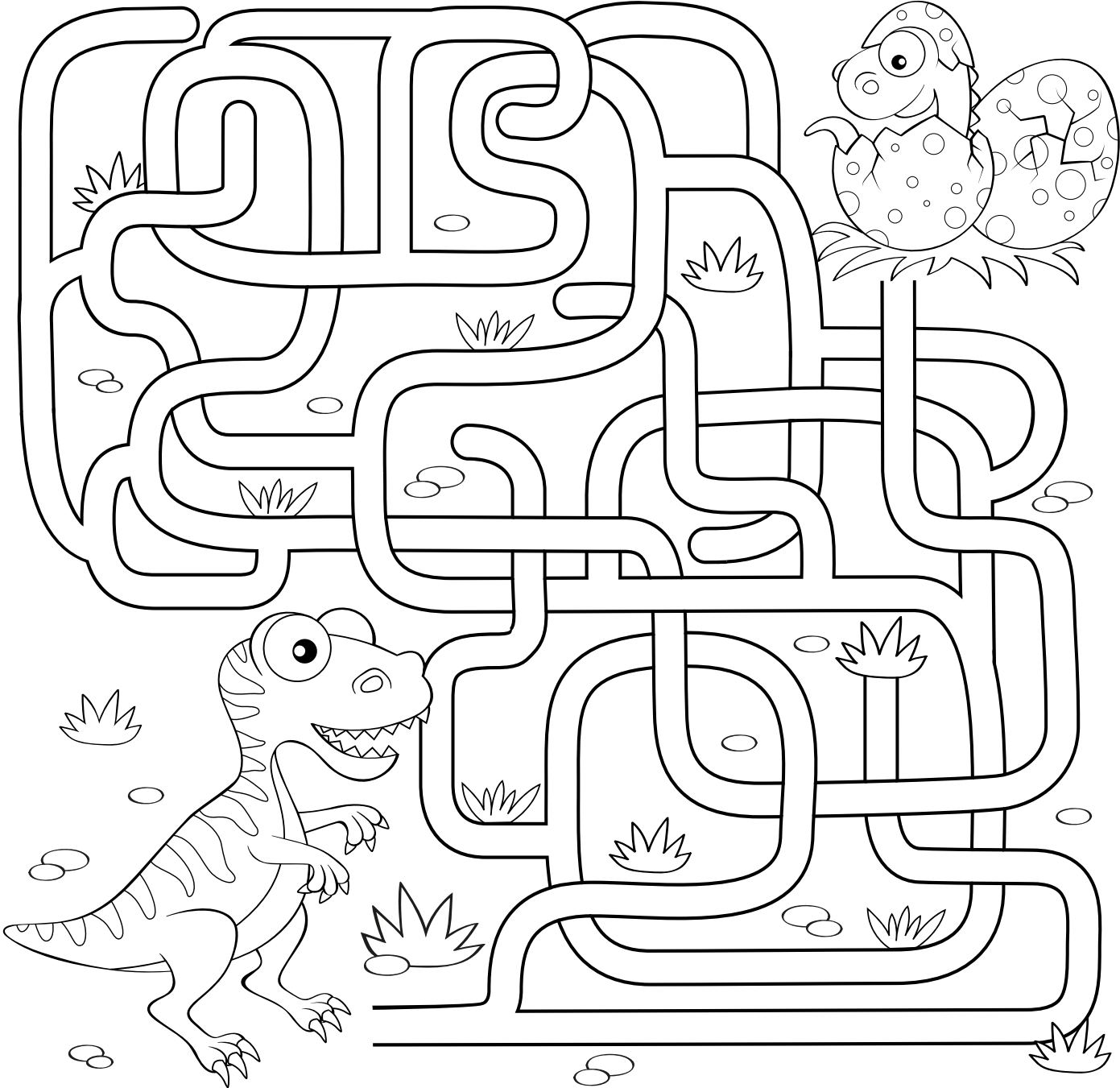

Start here

FIND THE RIGHT PATH

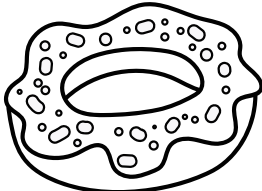
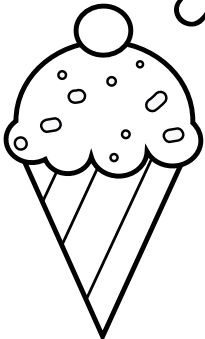
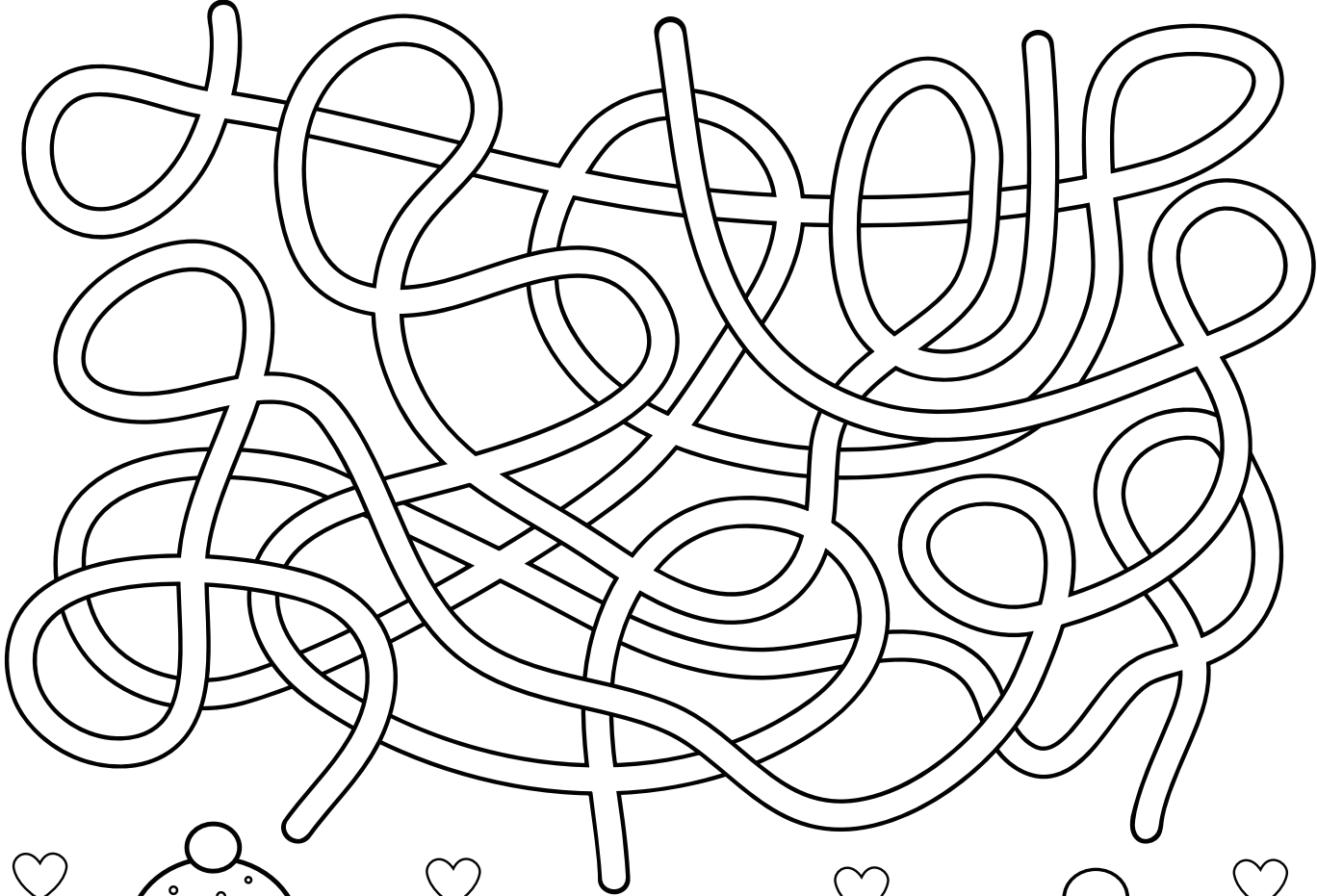
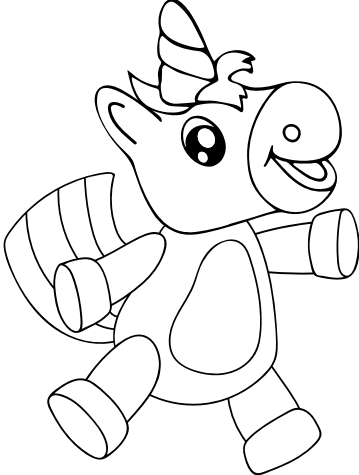
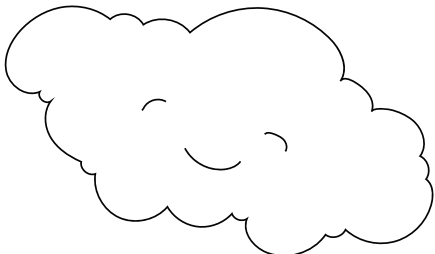
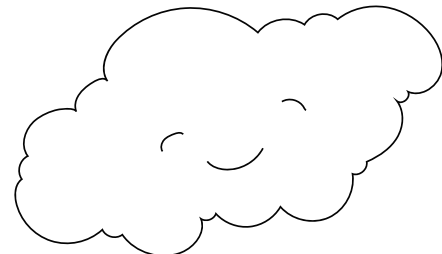

HELP THE ROCKET SHIP REACH THE MOON!

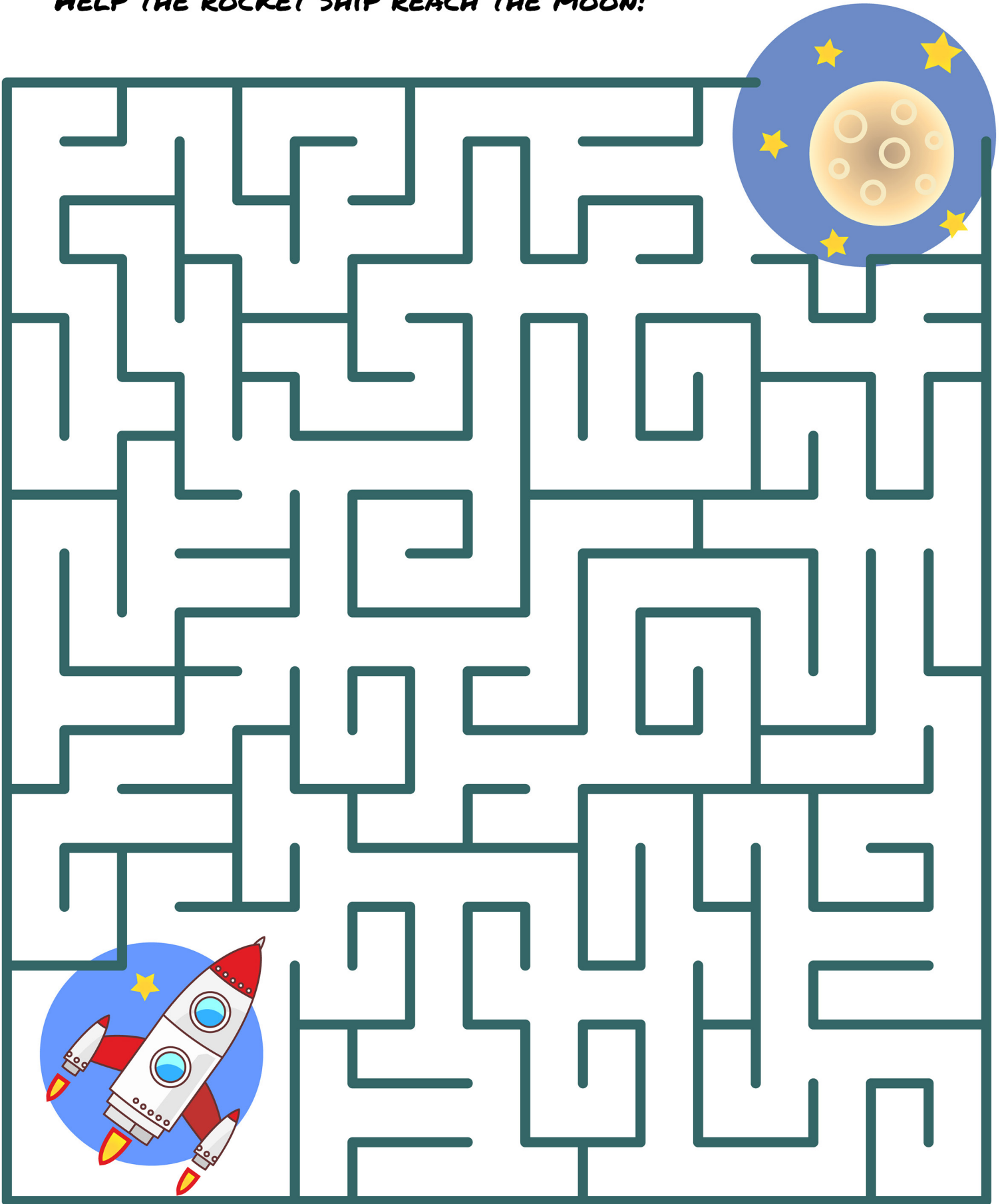

CONNECT THE DOTS!

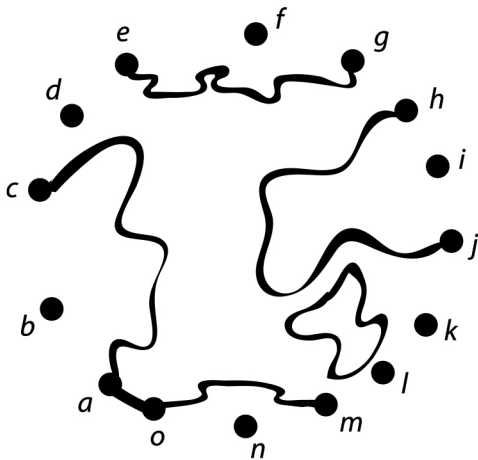
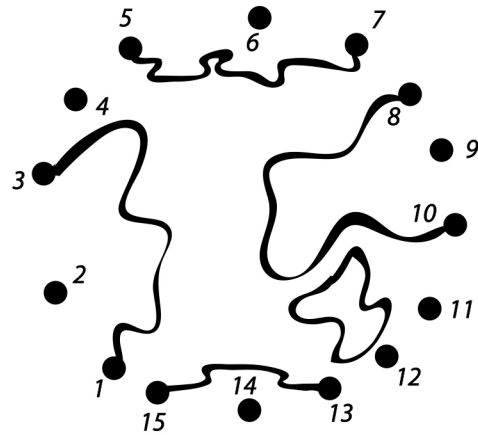
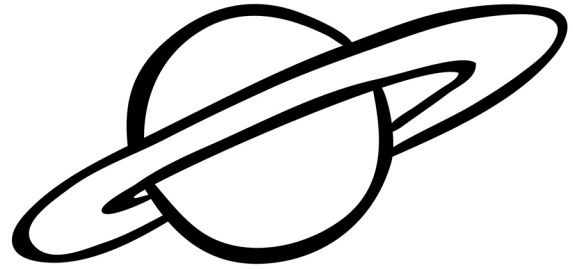
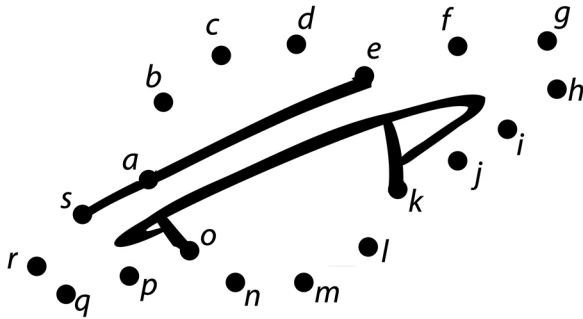
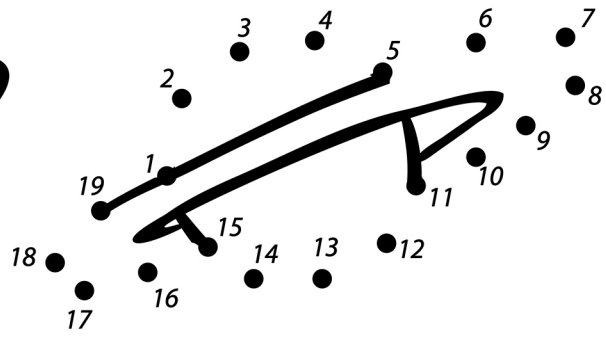
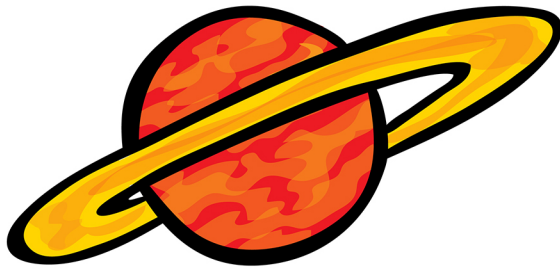

.....
Connect the dots
.....

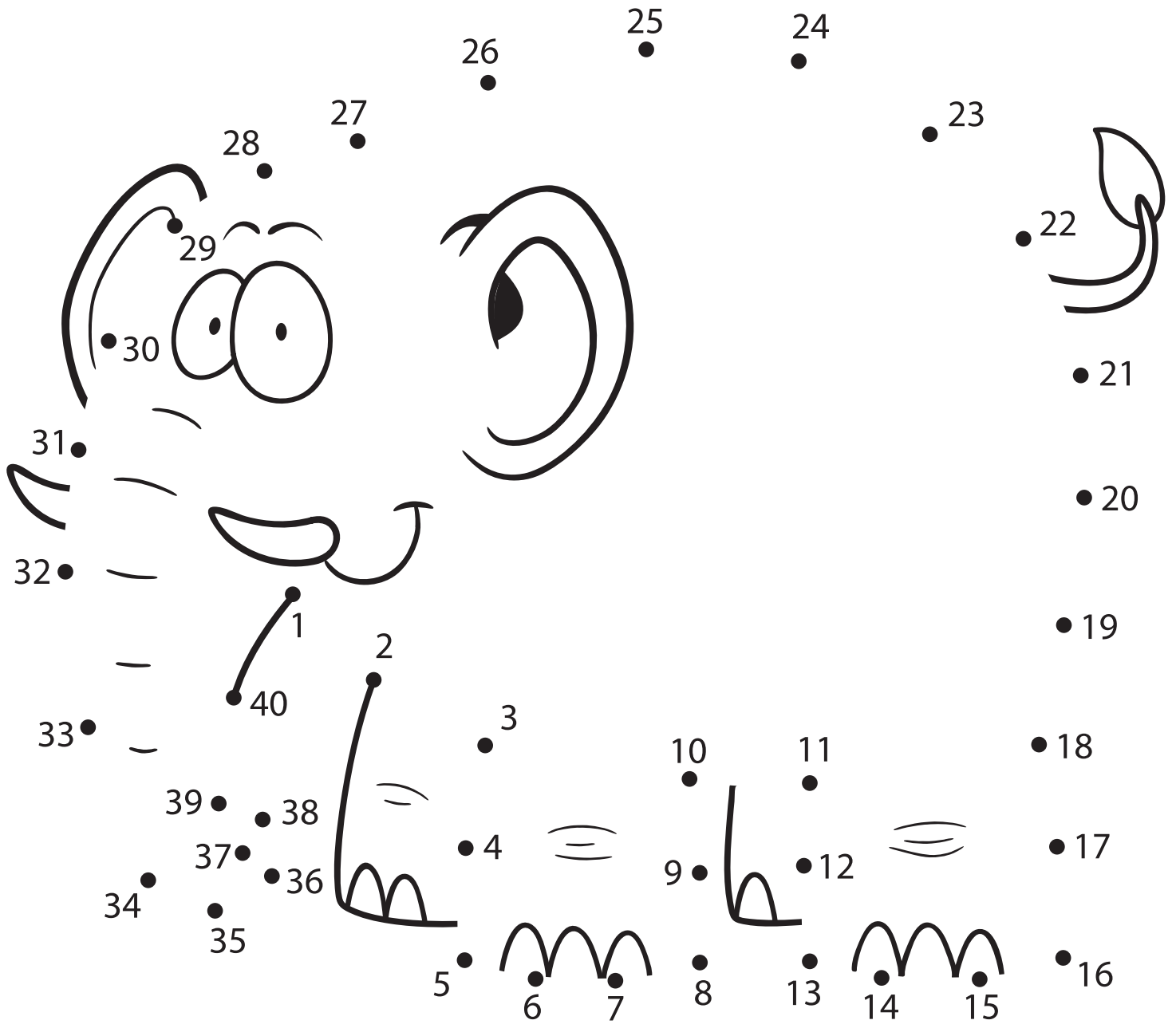

.....
Connect the dots
.....

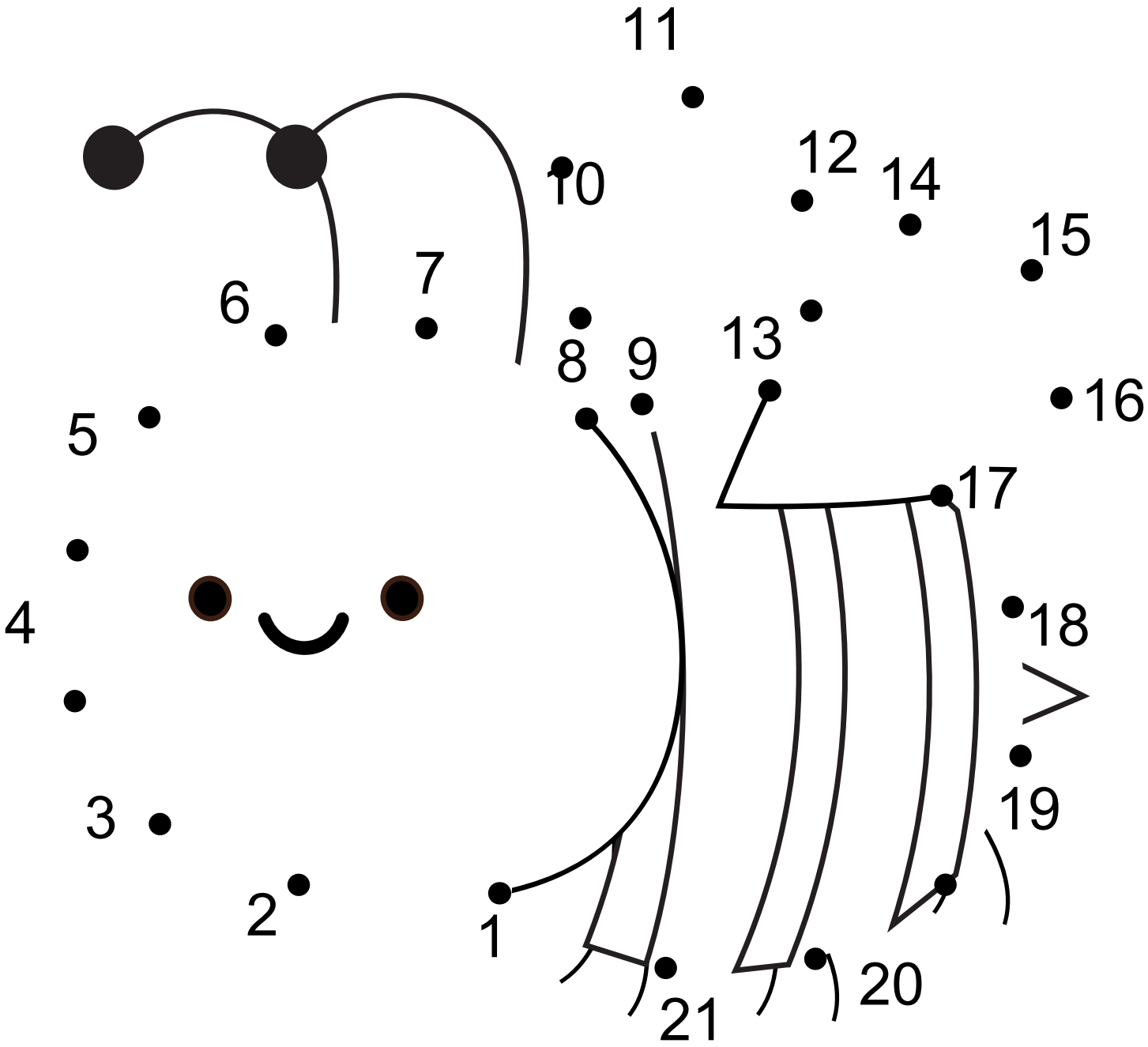

Connect the dots

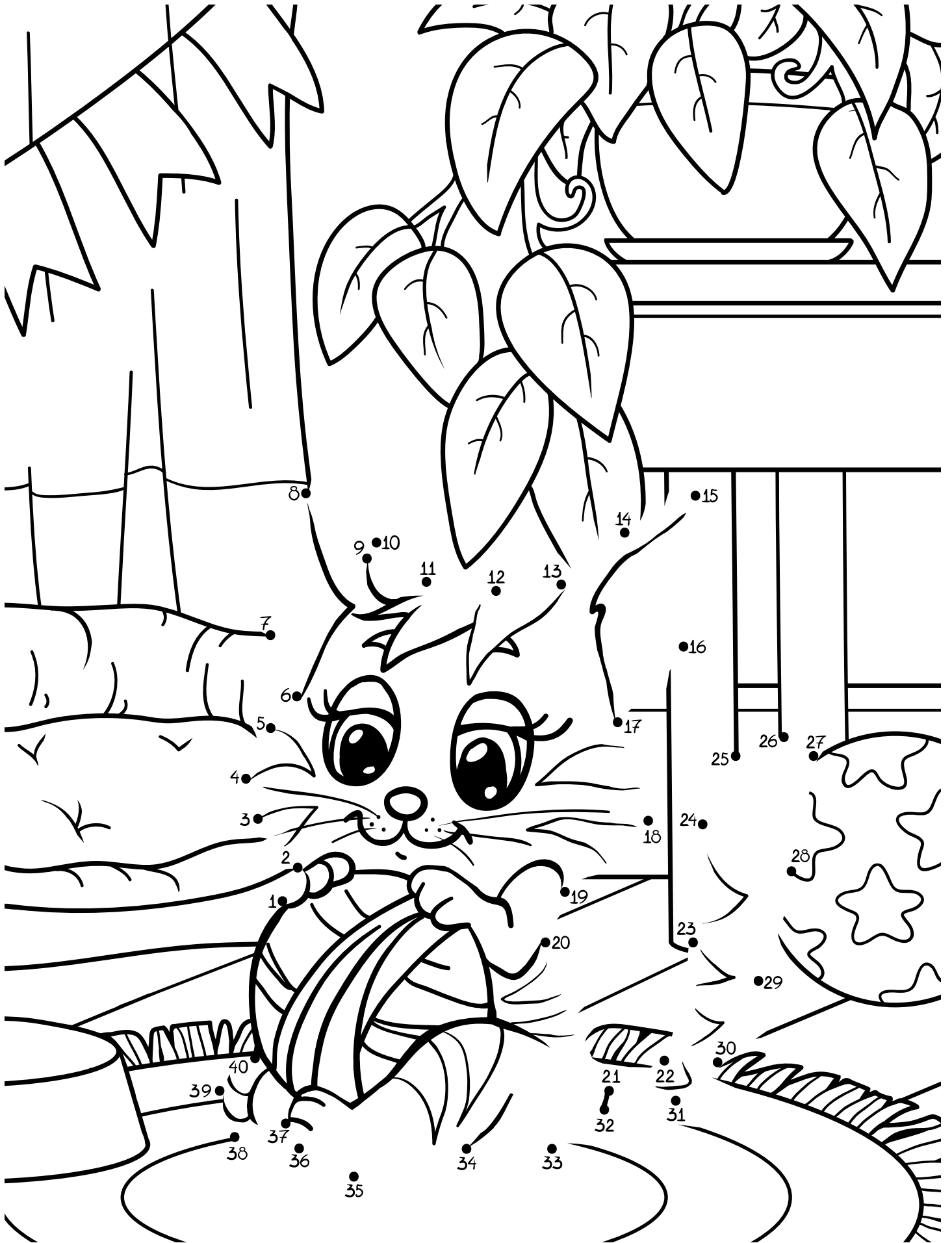

Connect the dots

