



Activities Book

for children and adults

Thank you notes • Inspirational messages
Coloring pages • Games



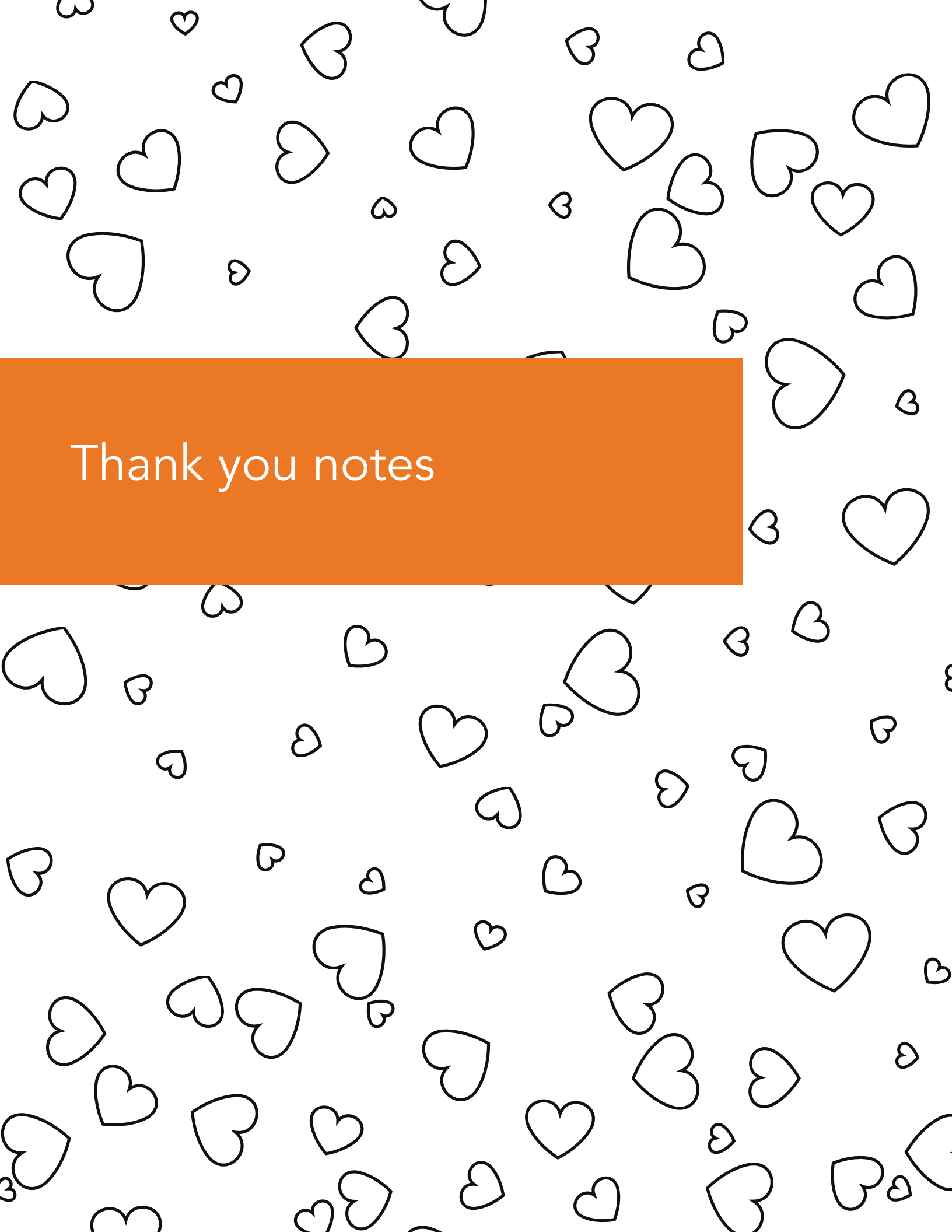

Thank you notes

Thank you
FRONTLINE WORKERS



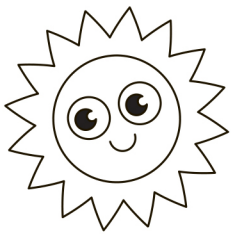

THANK YOU
FIRST RESPONDERS!

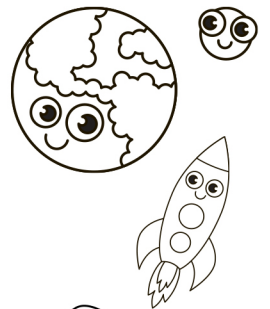

You are out of this world!

Thank You
FRONTLINERS

FOR YOUR SERVICE TO THE NATION, WE SALUTE YOU!

PLEASE STAY SAFE!

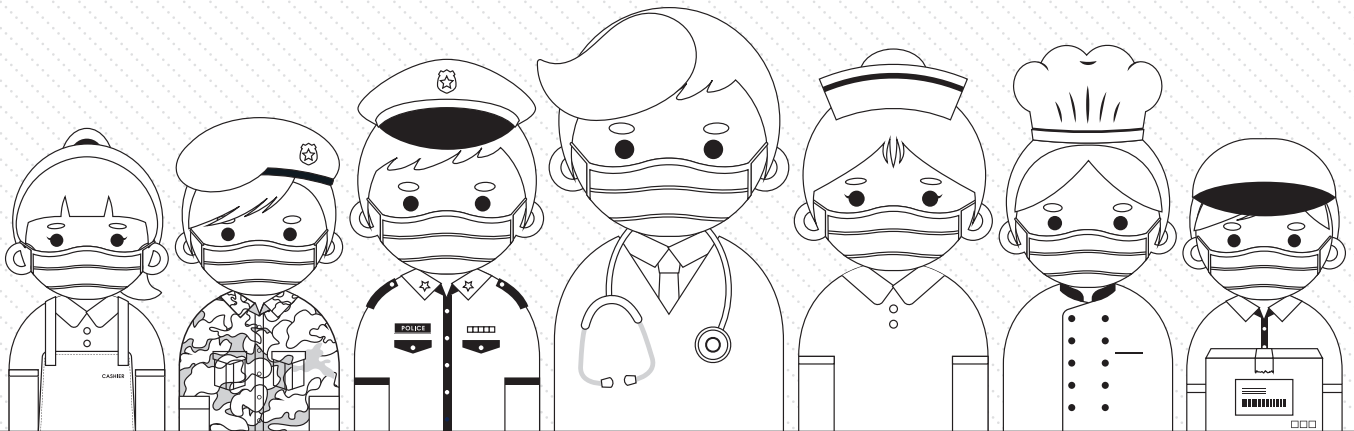

We are
FOREVER
grateful

Thank you
FOR all
& you DO!







Dear _____ ,

THANK
YOU

Dear _____ ,

Miss you!

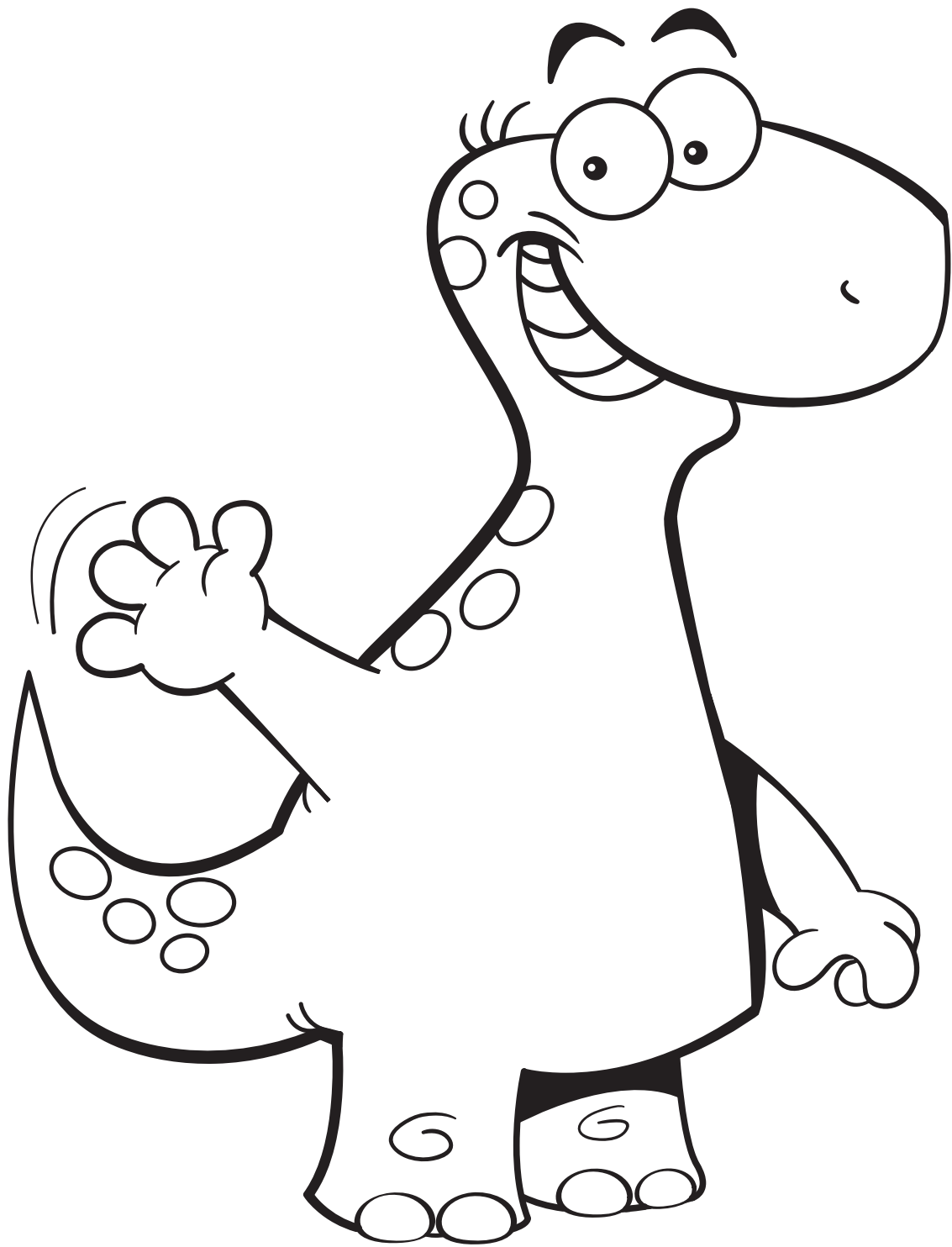

Thanks for keeping
me safe!

You are my



HERO

You are my



HERO



Inspirational messages

Smile



Positive
Energy



ATTITUDE IS A

Little thing

= THAT MAKES =

•  •
A BIG DIFFERENCE •

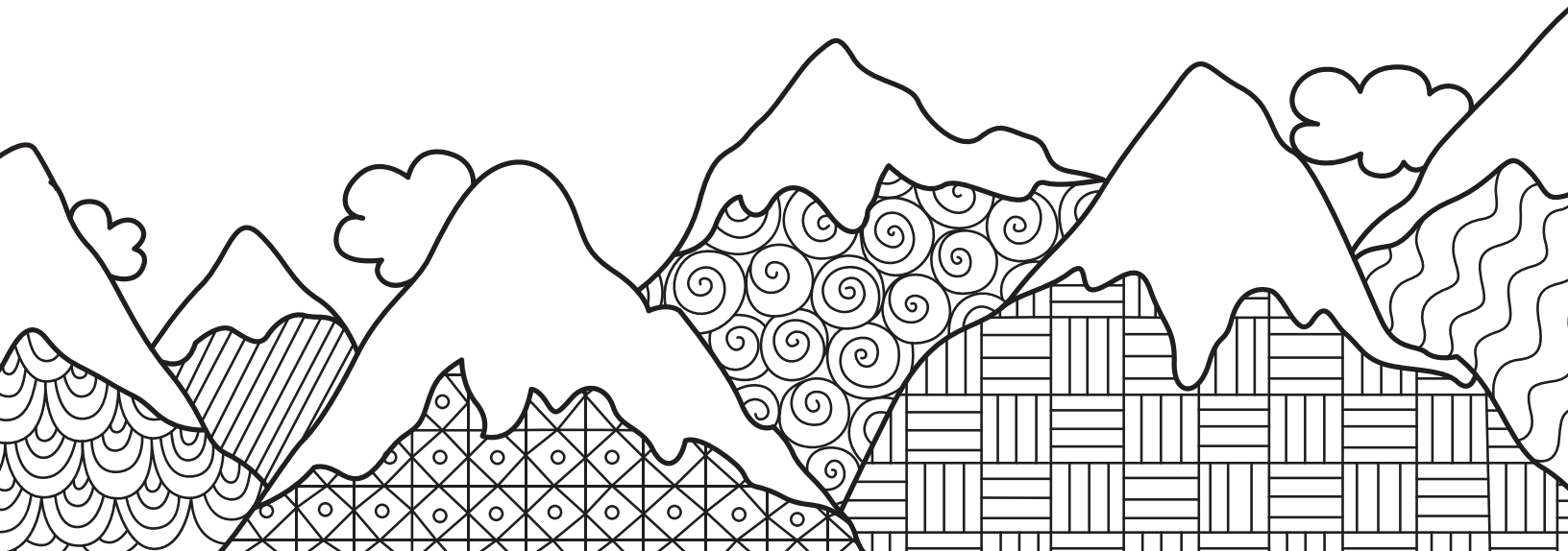



Toes
in the



Sand

You are my
sunshine, my
only sunshine
you make me
happy when
skies are gray

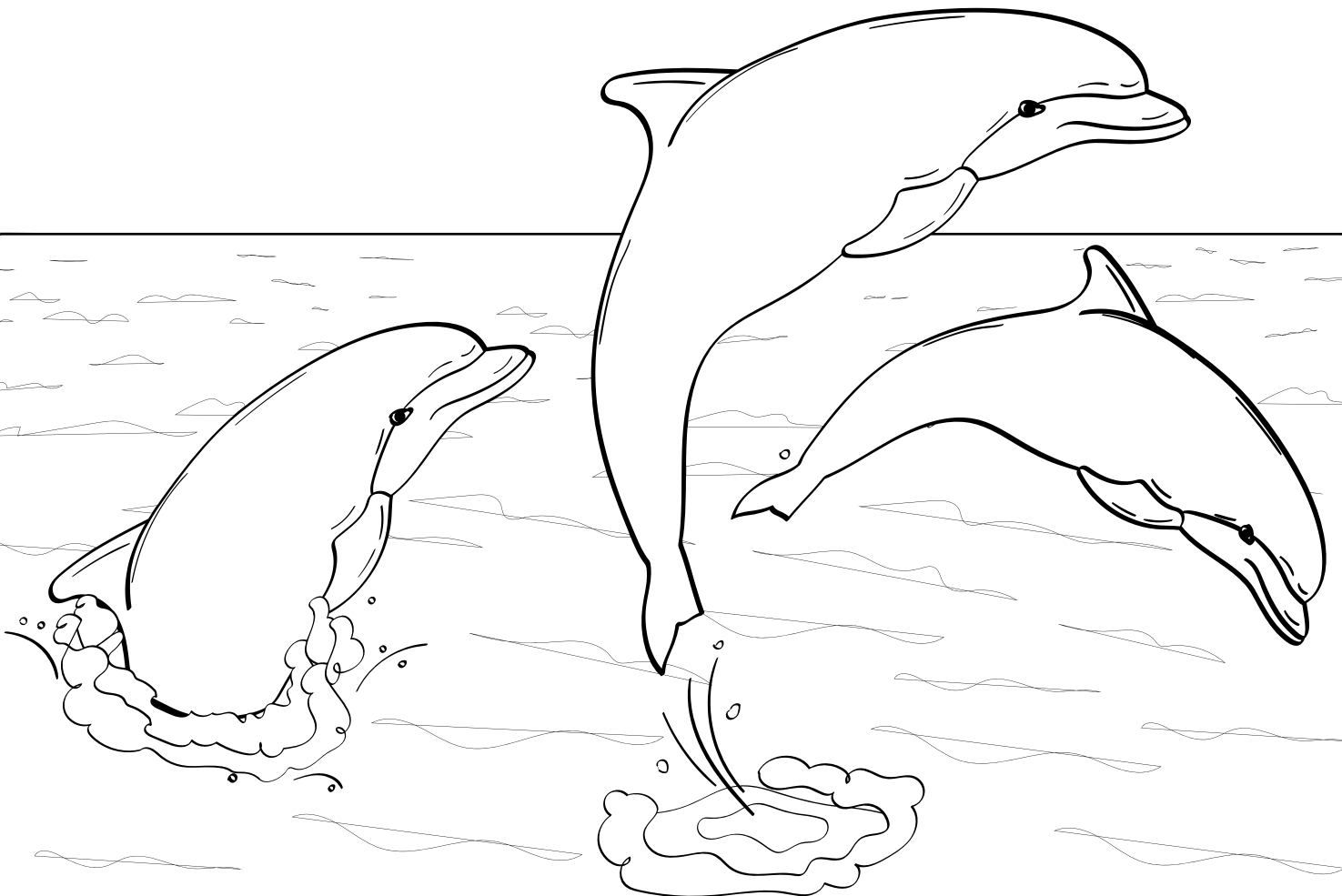
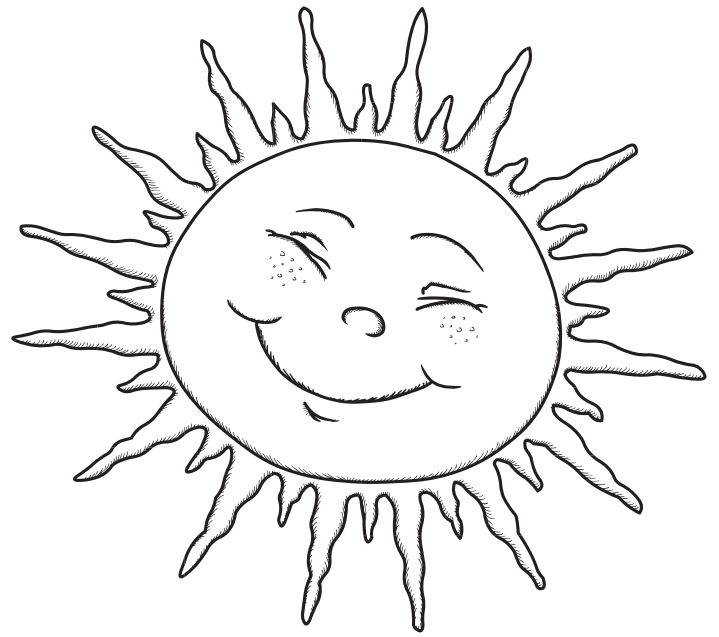



Coloring pages



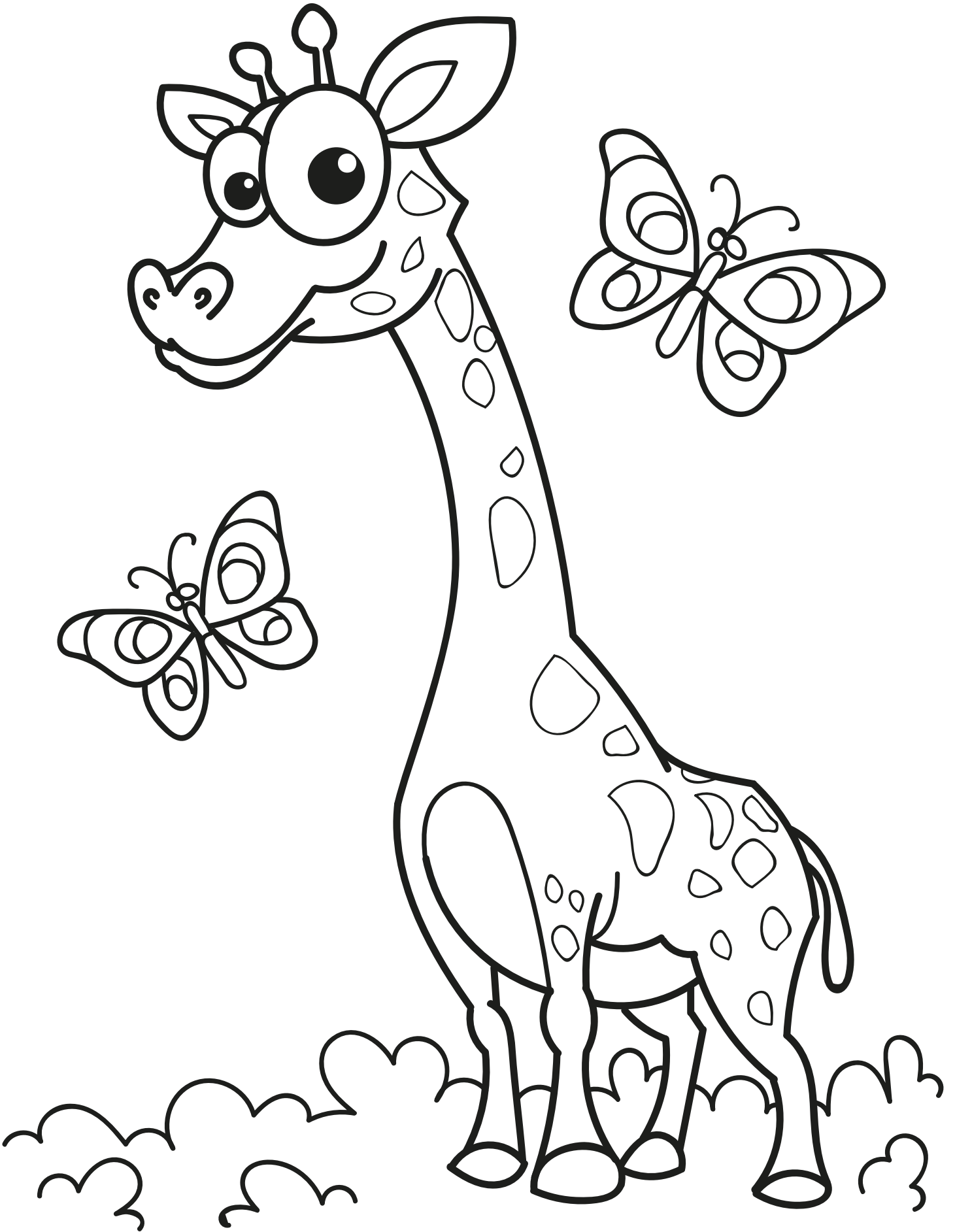











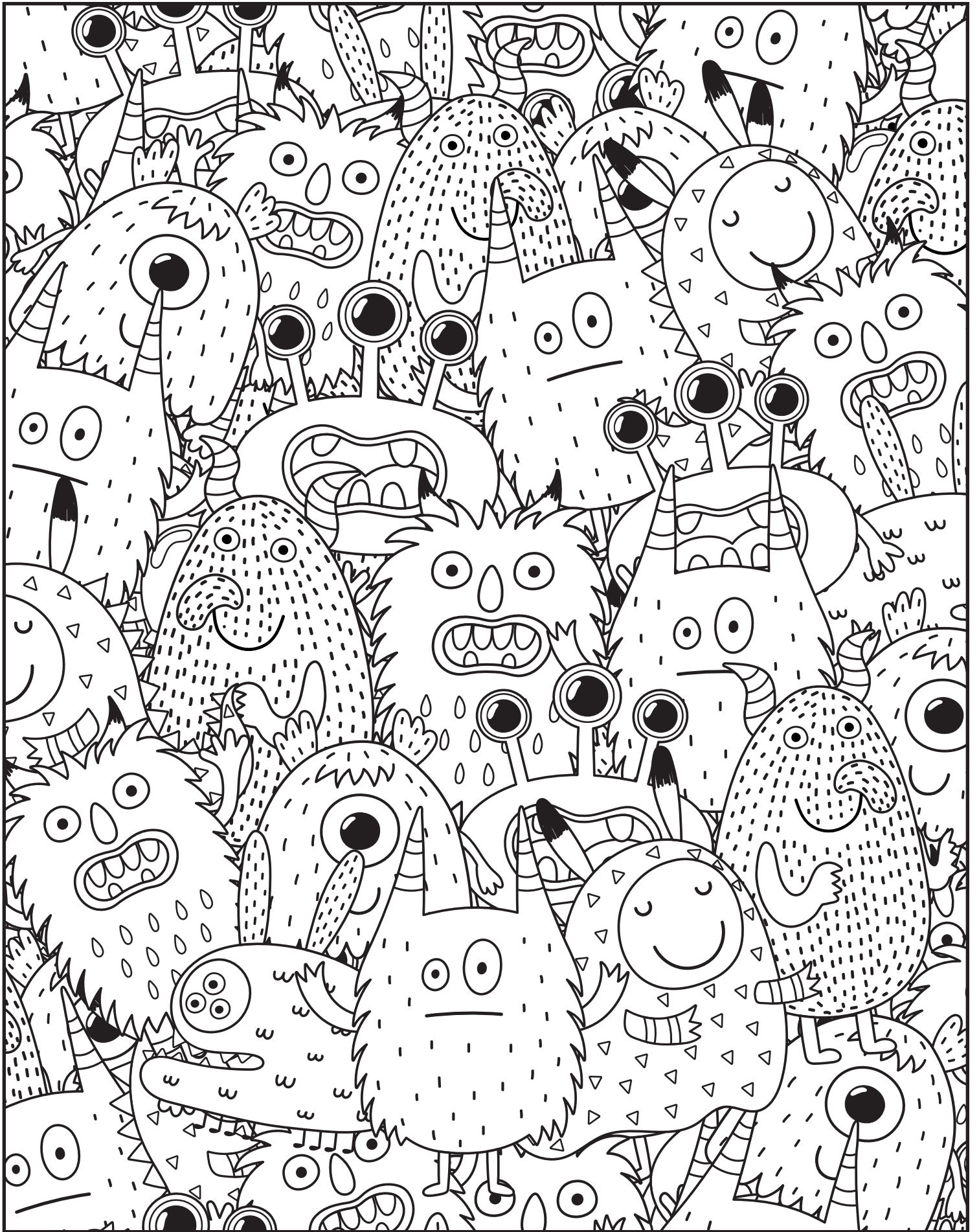

SPACE Travel

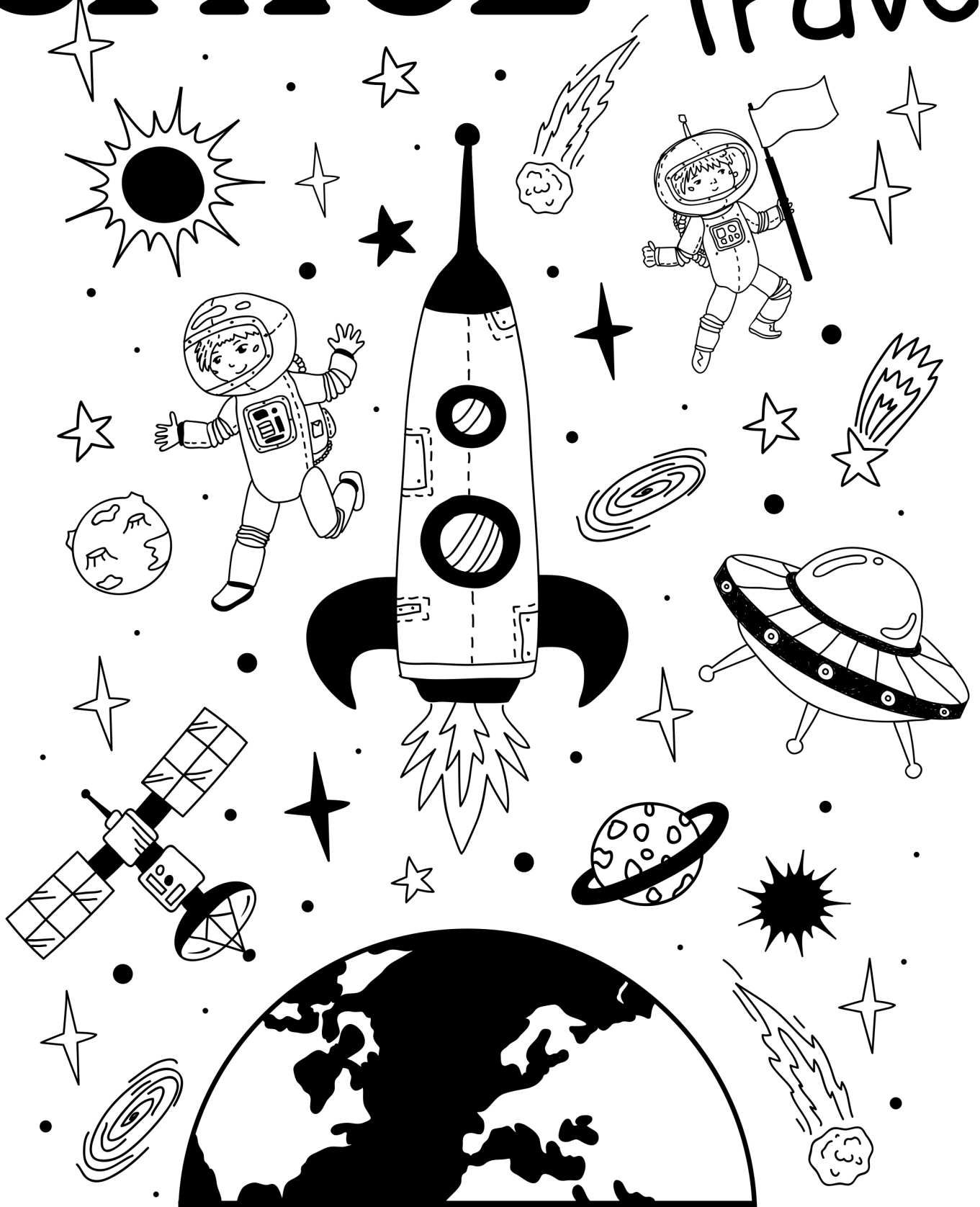

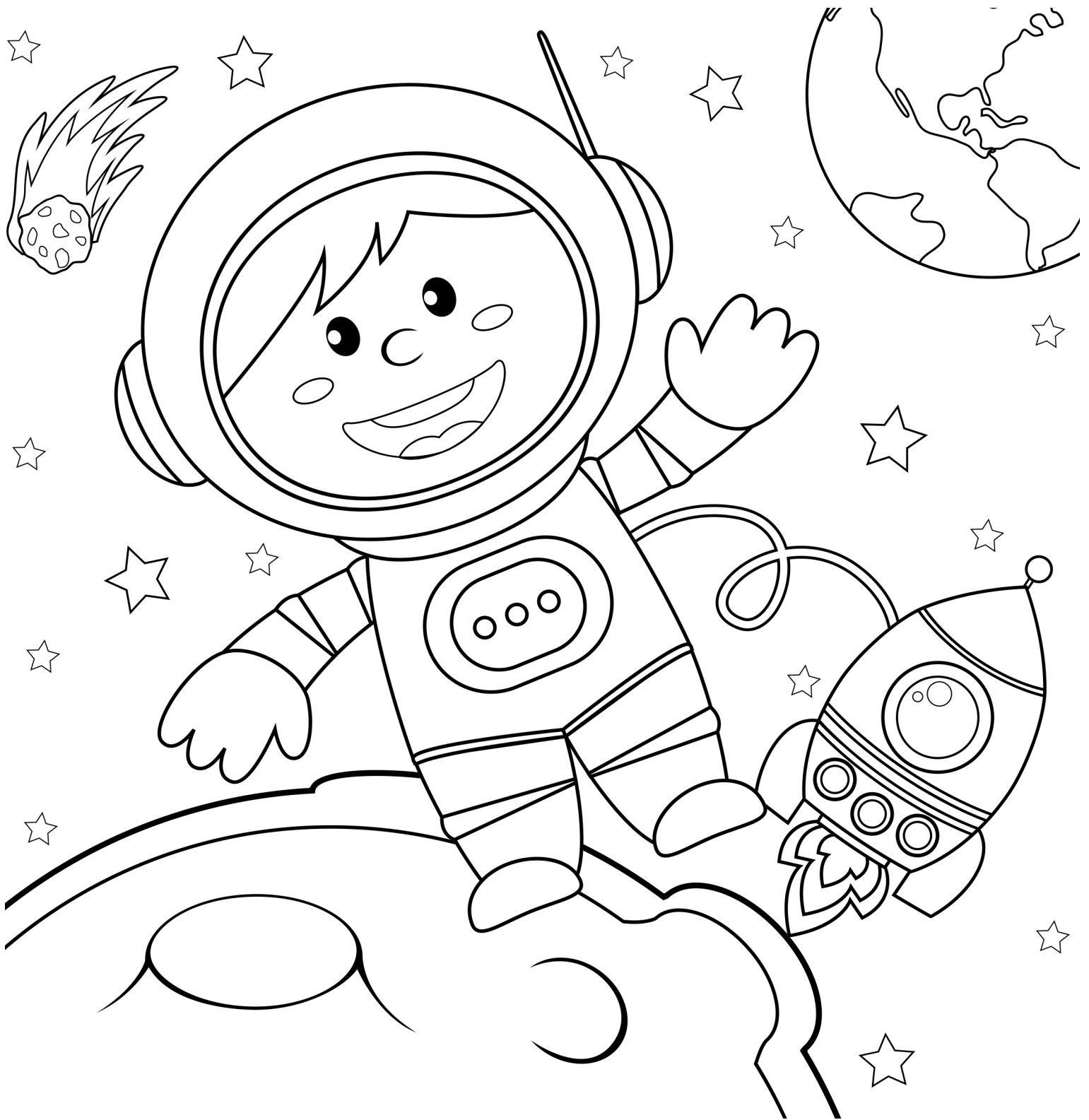

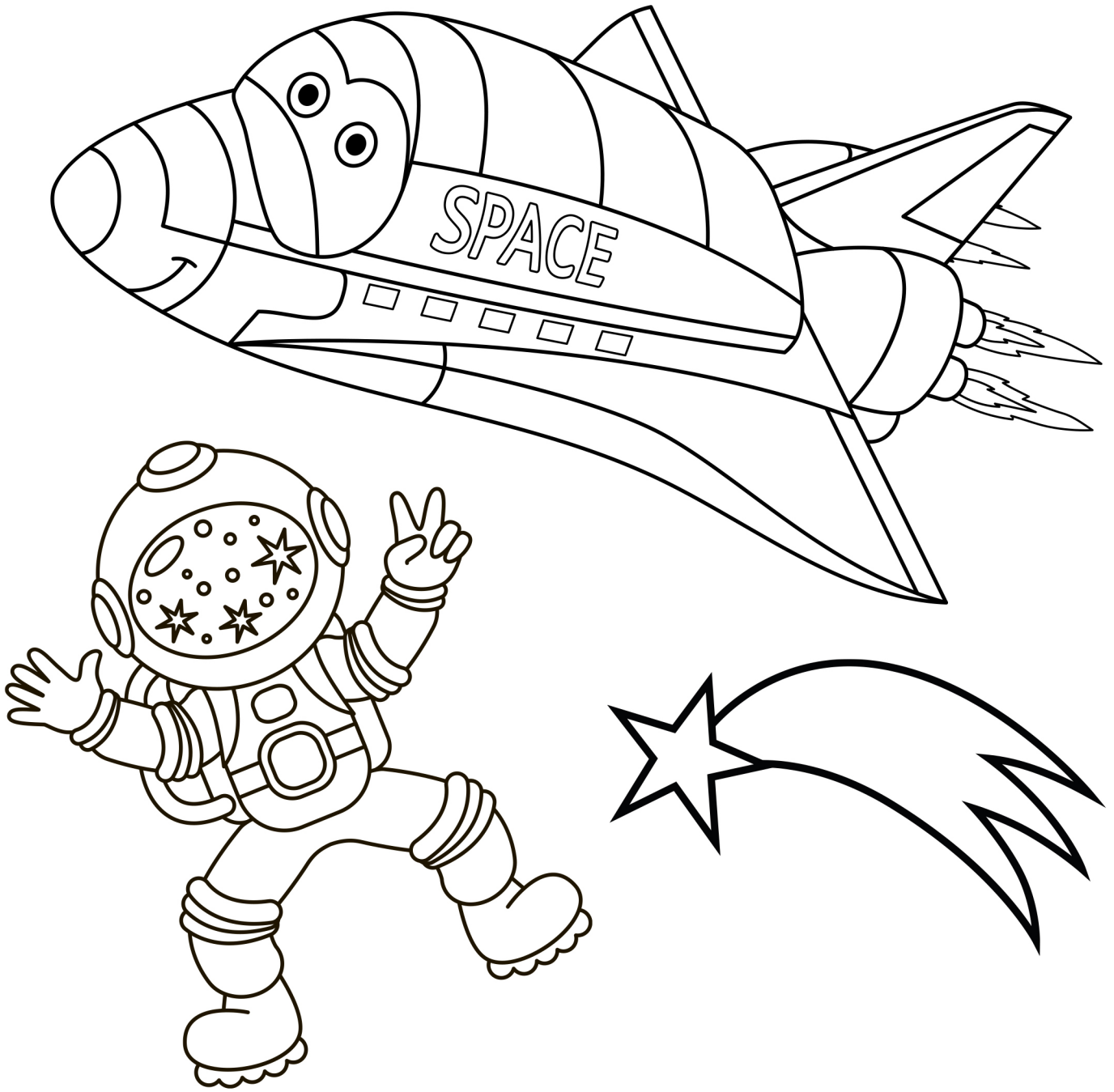

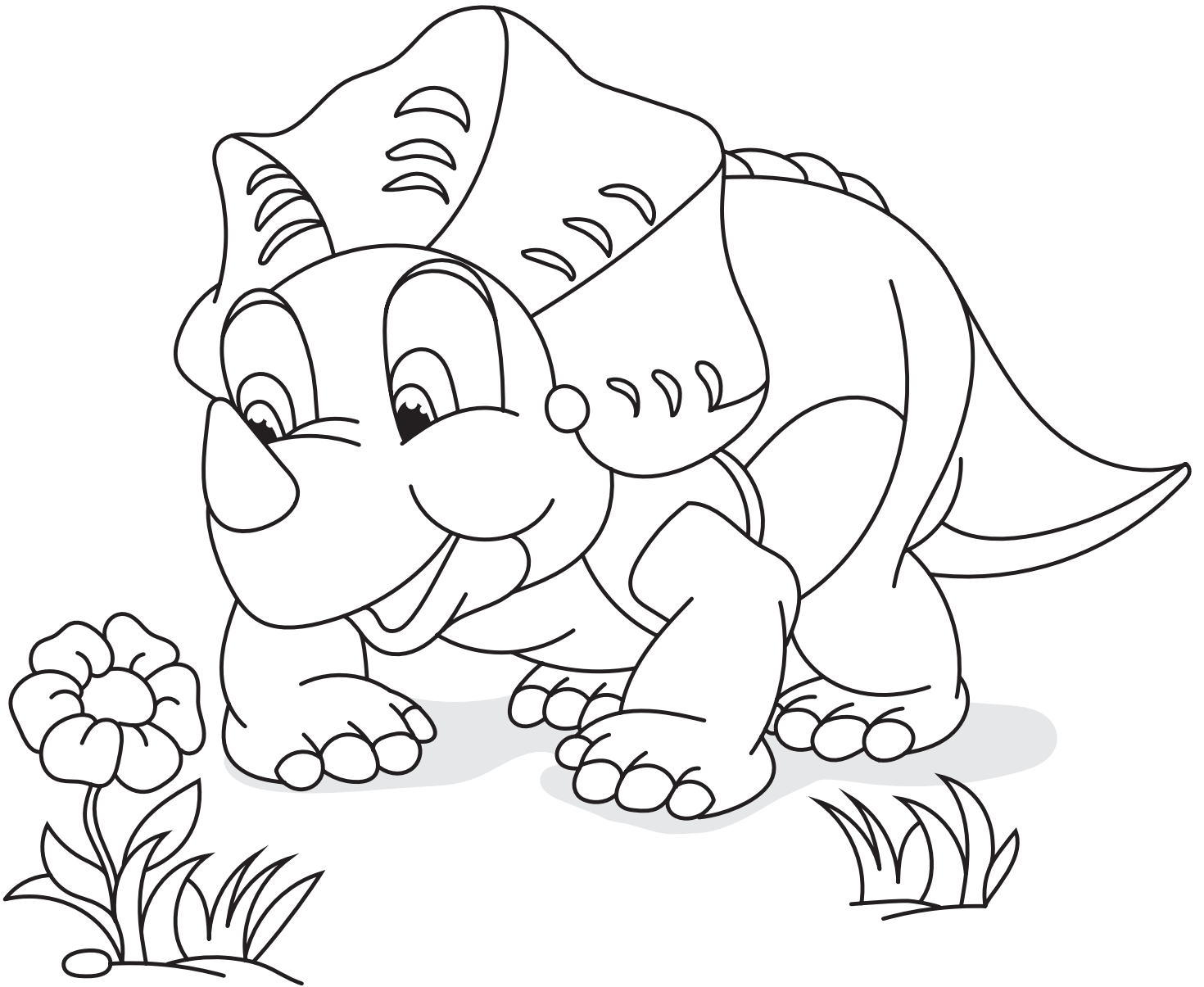

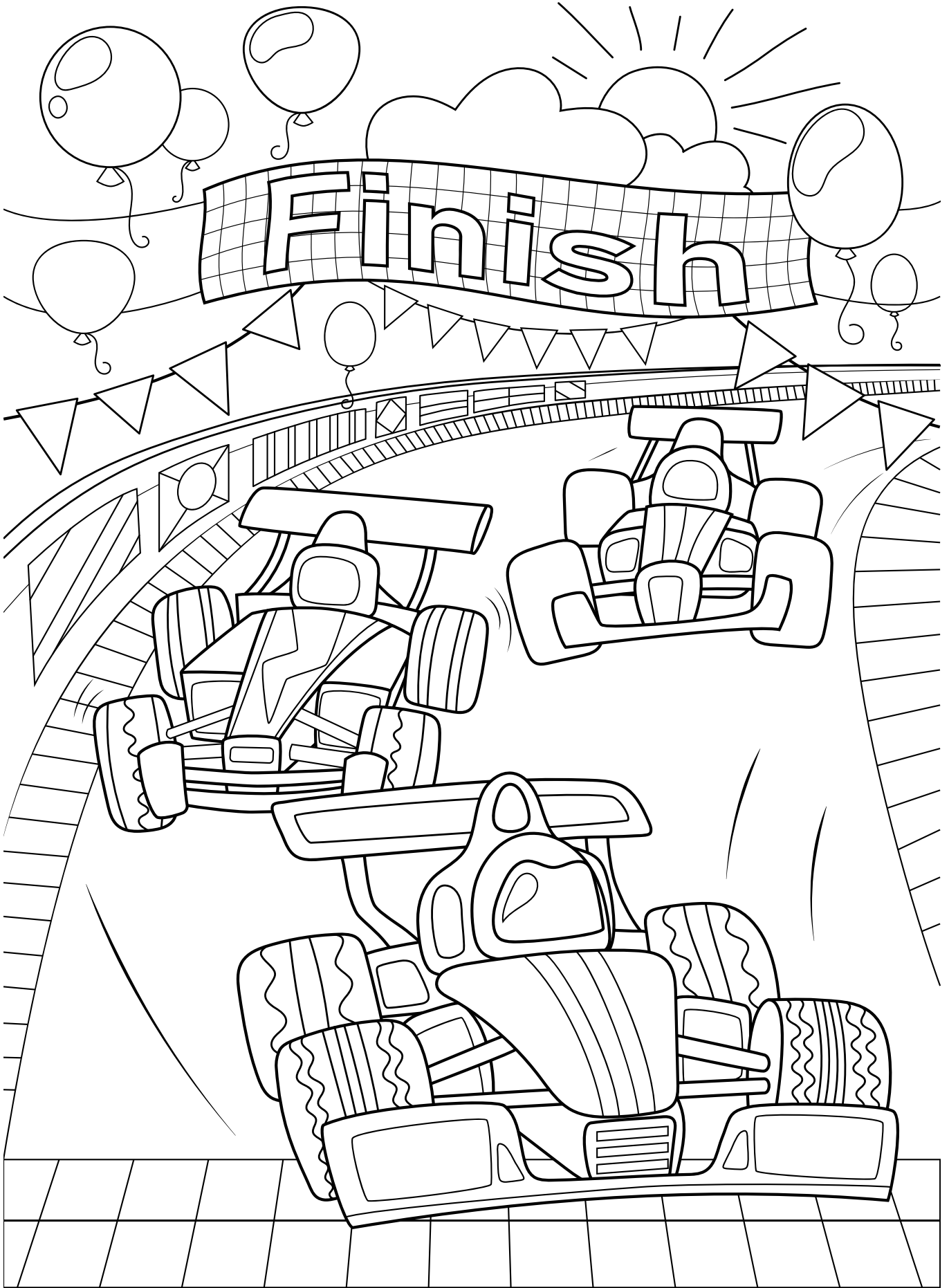

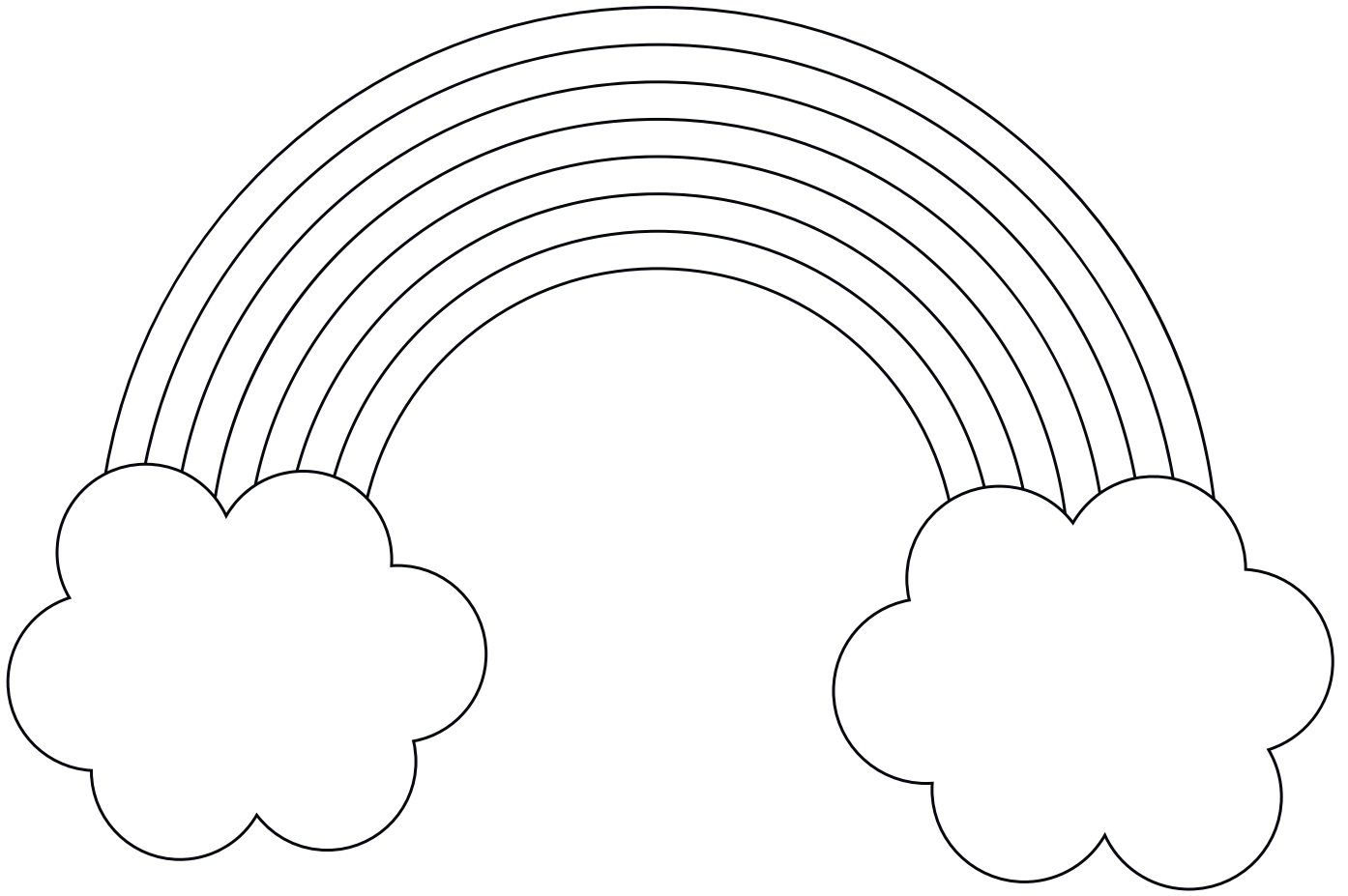

DAD DOT

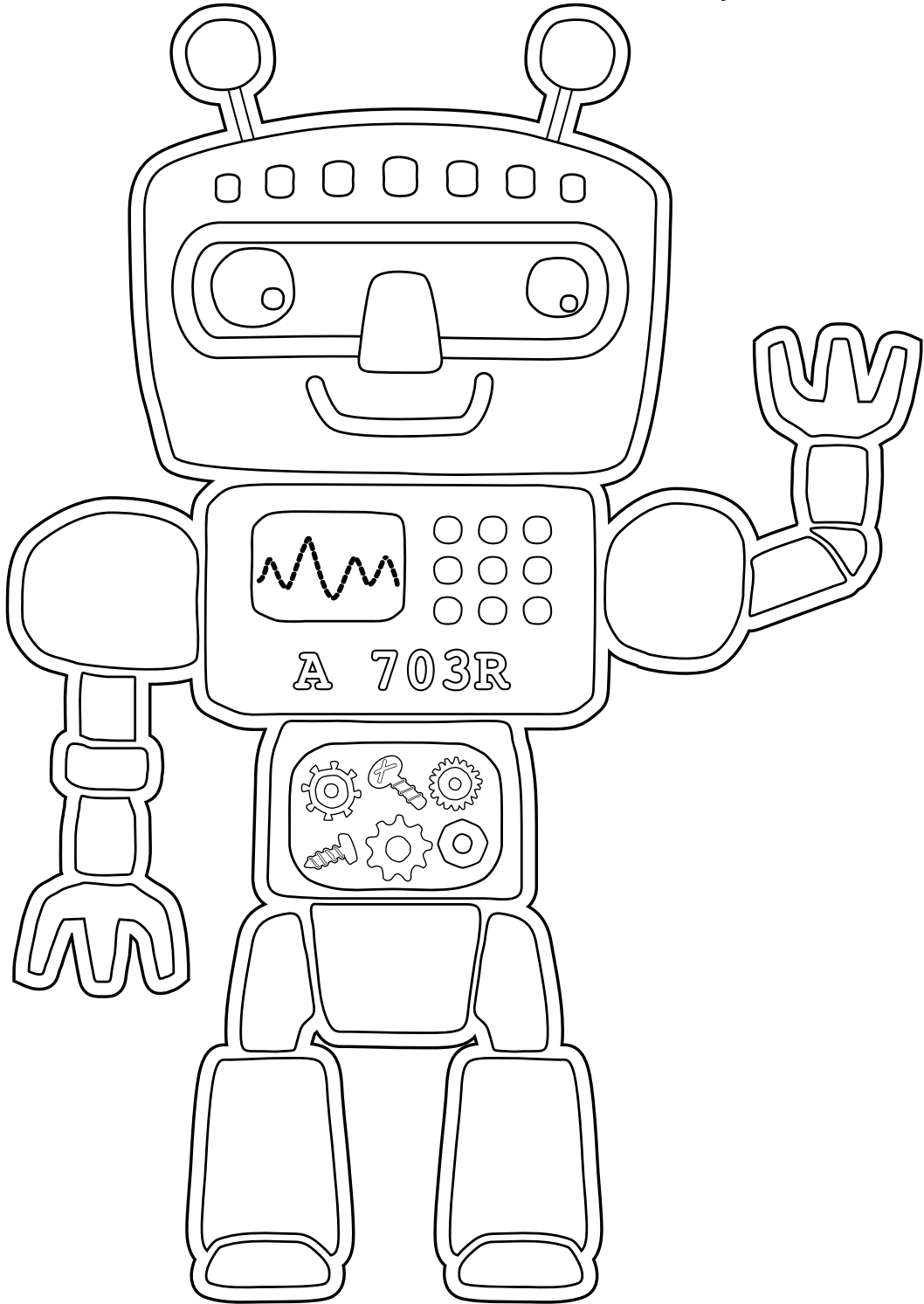

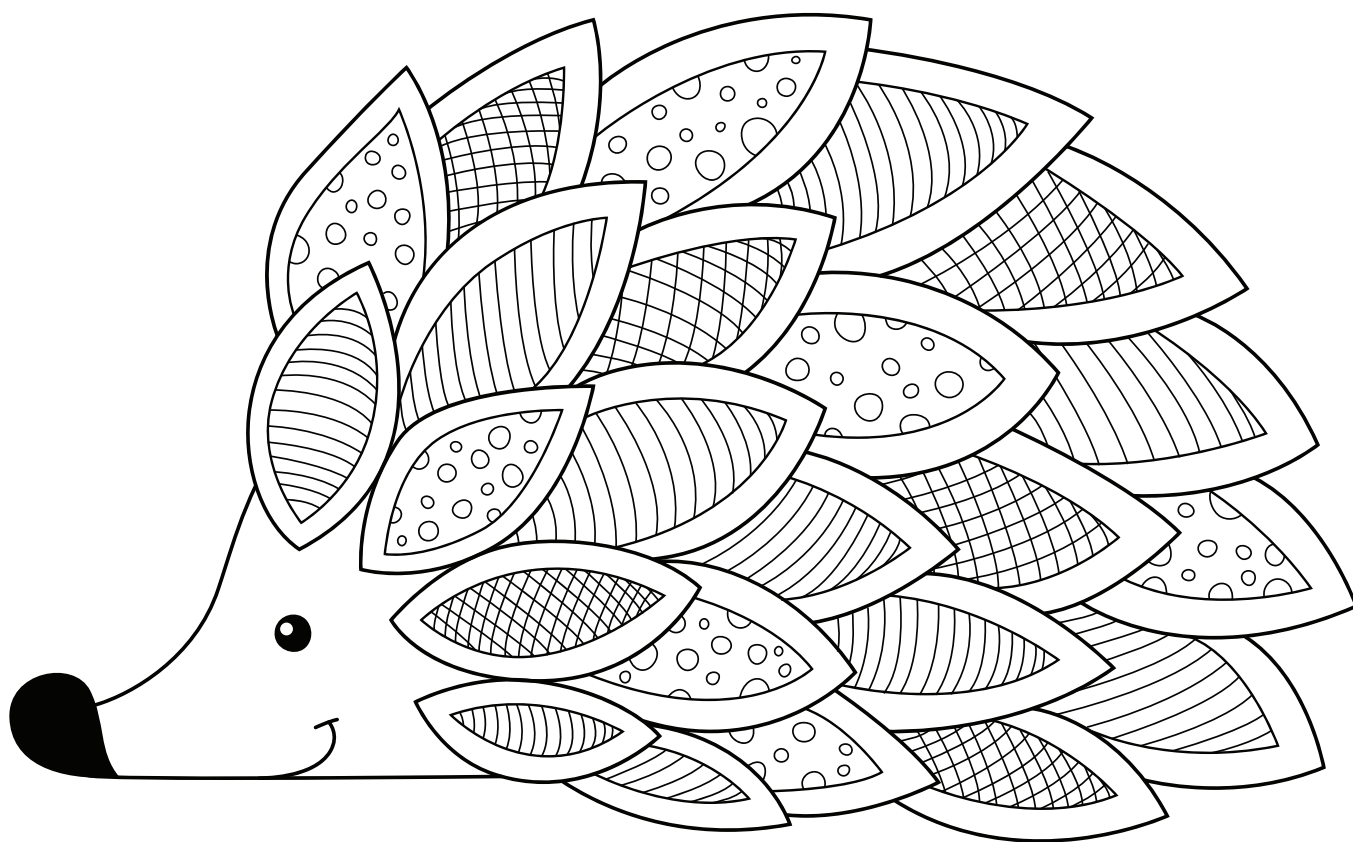



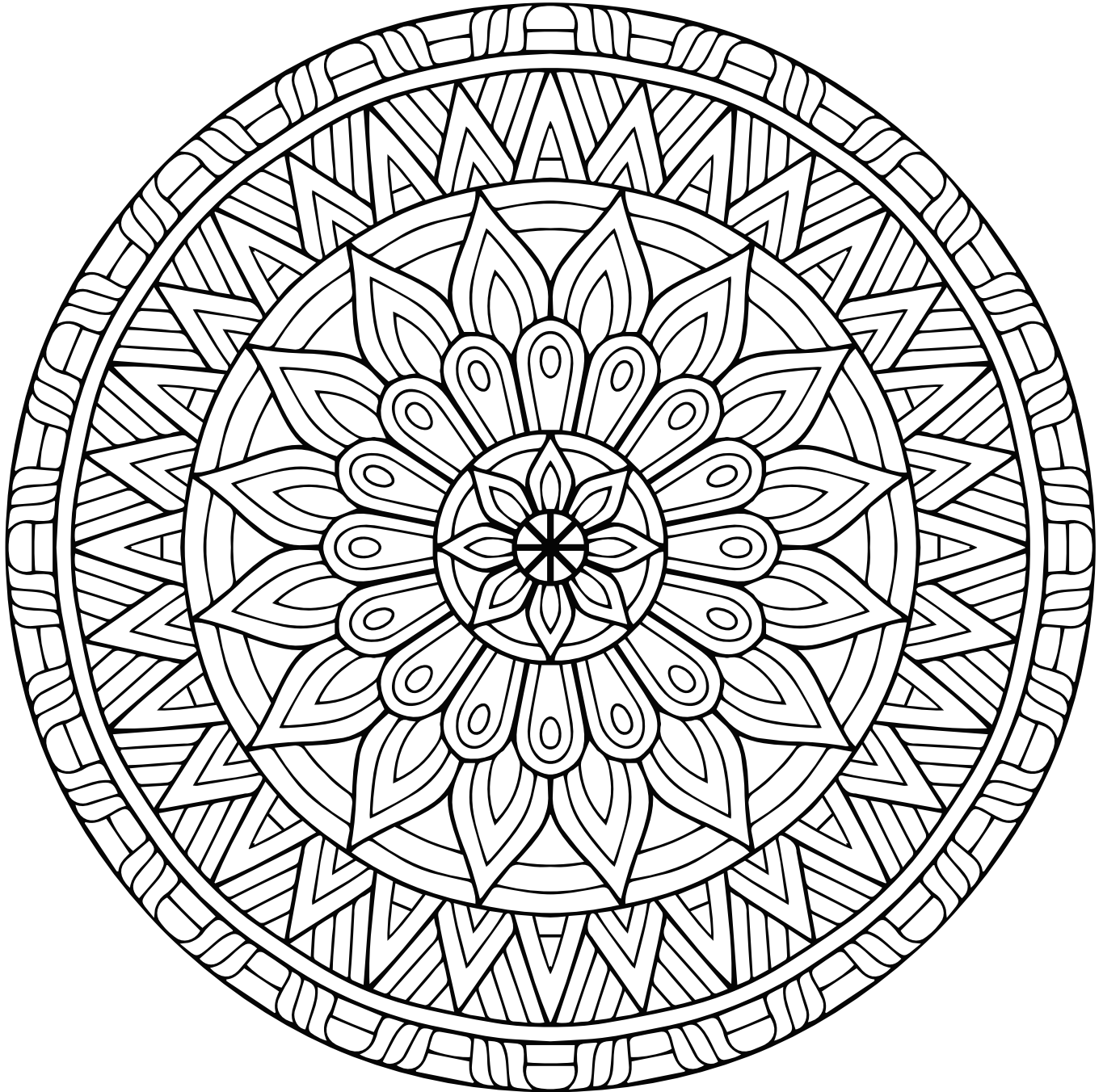



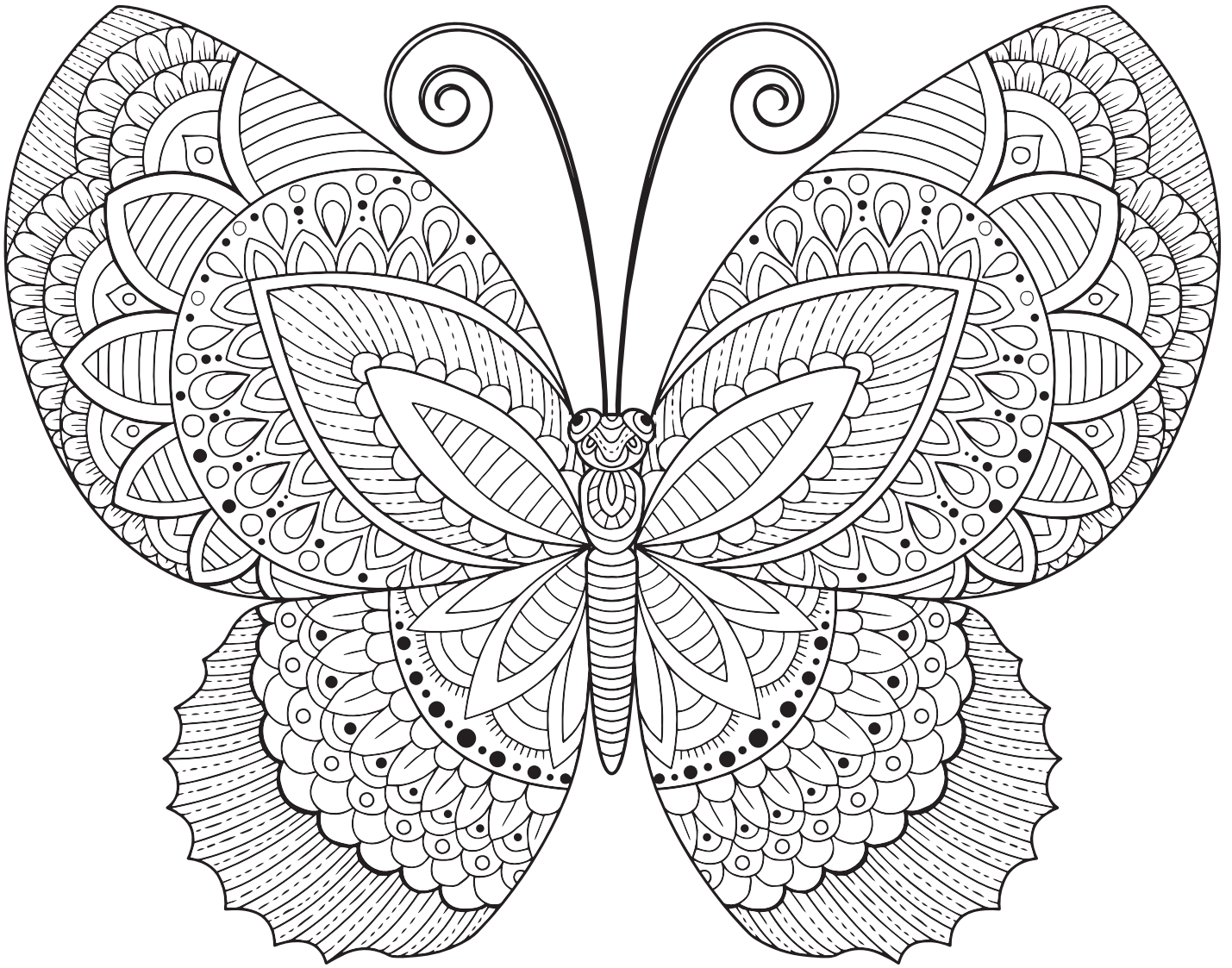



Games

Color the llamas
and cut them out!

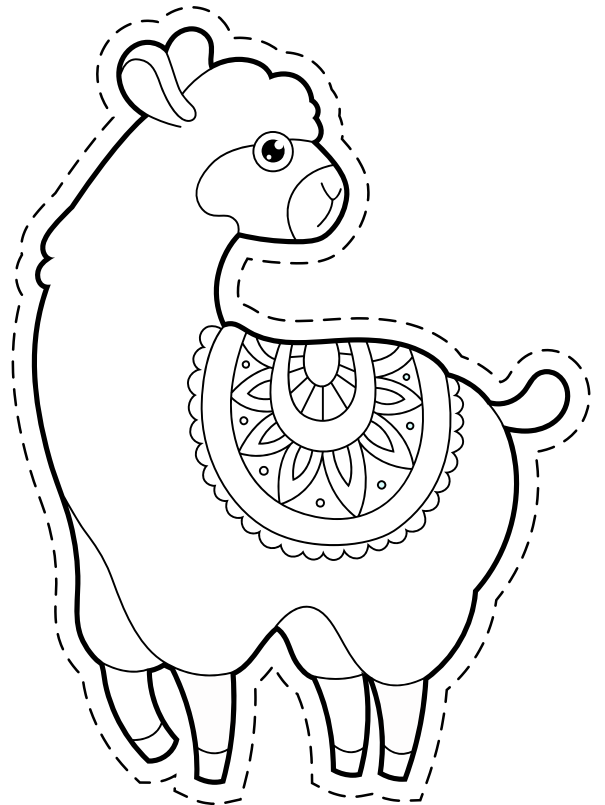
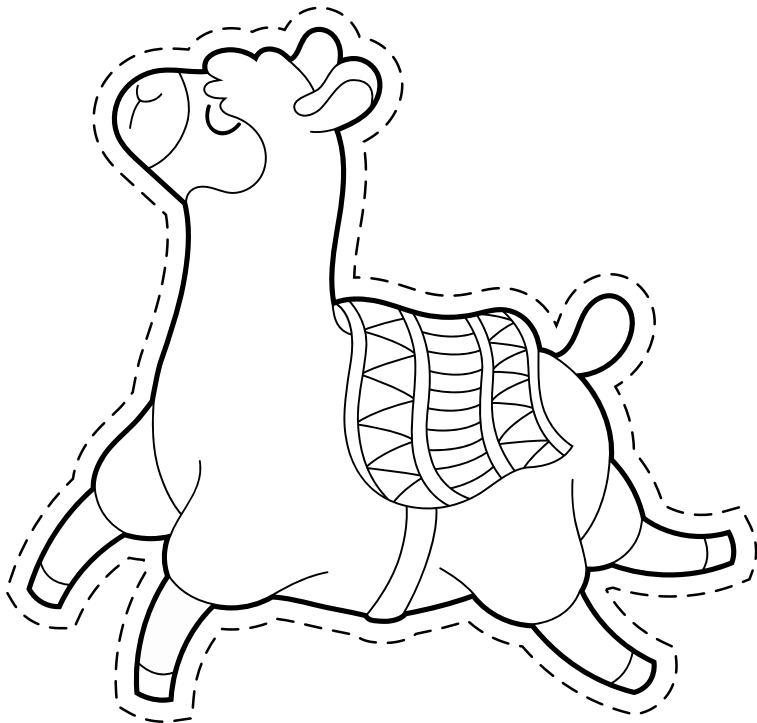
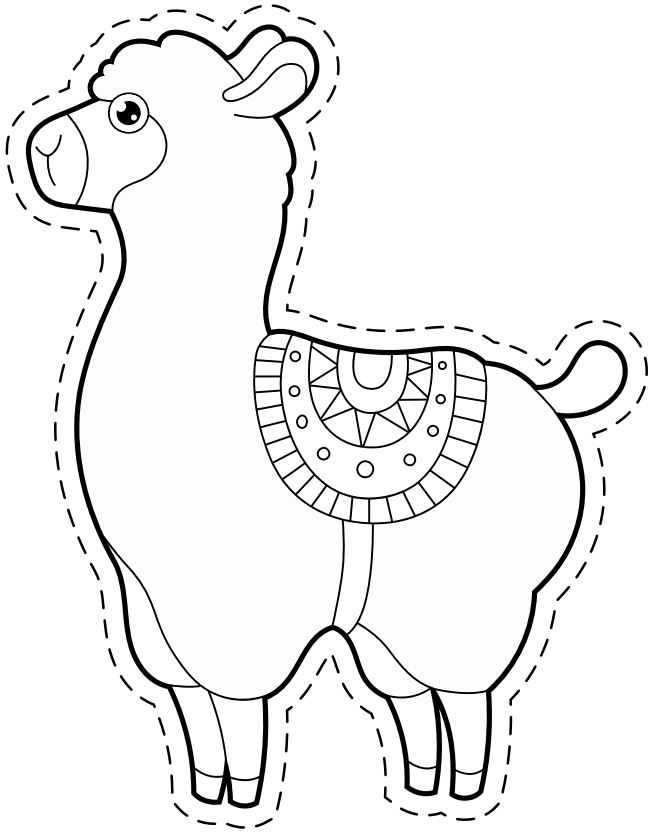

Color the hearts, cut them out, and hang them in your window for all to see!

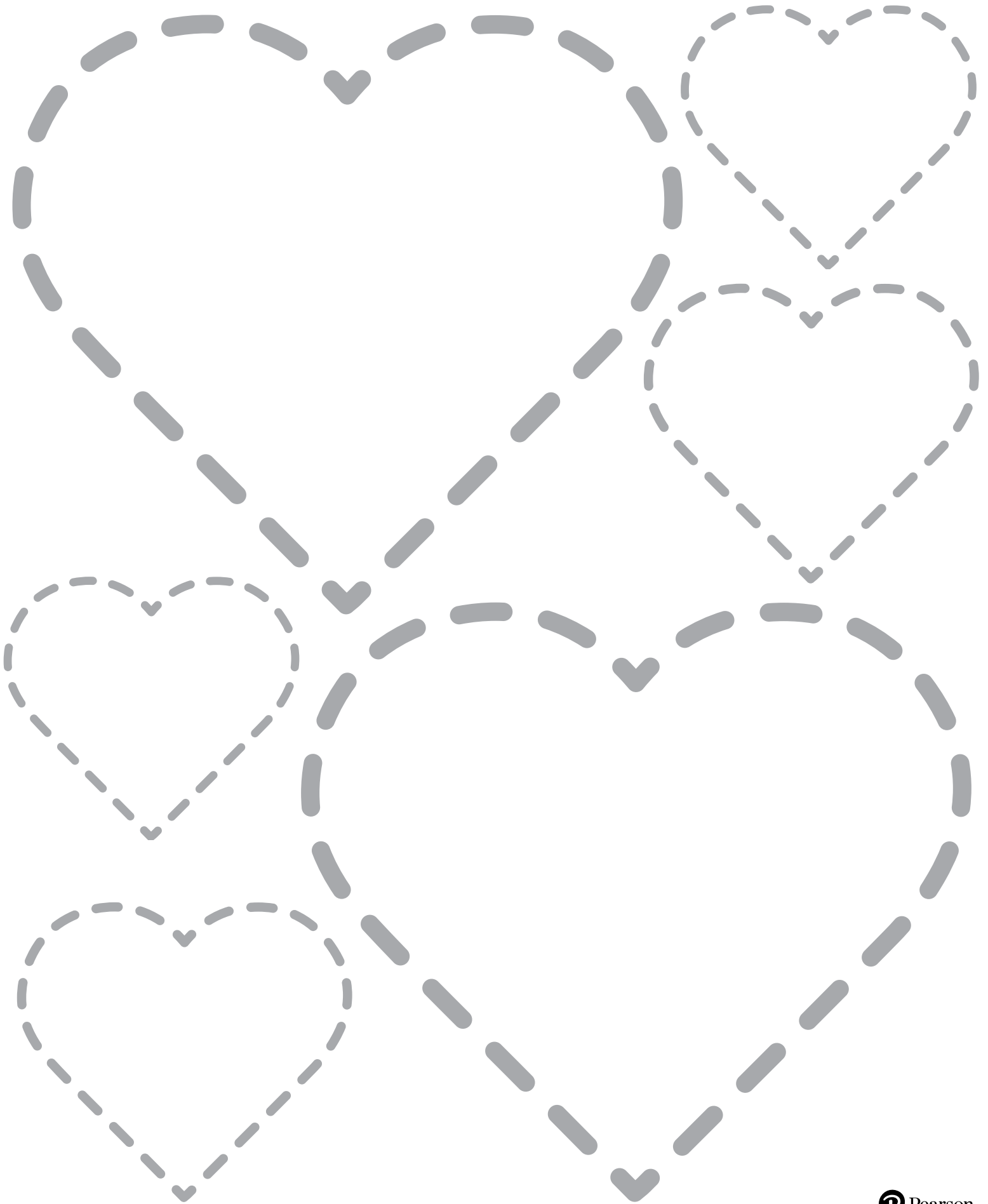

BUNNY BOOKMARK

COLOR PRINT and CUT OUT



cut on the dashed line

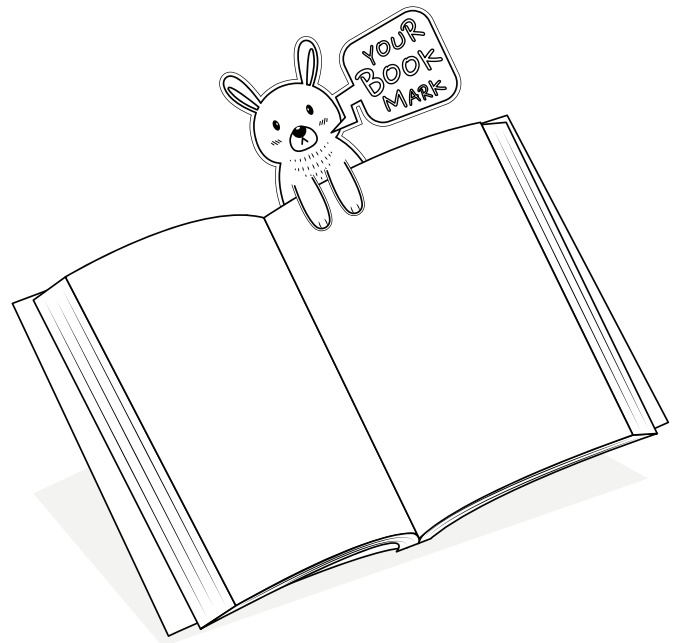

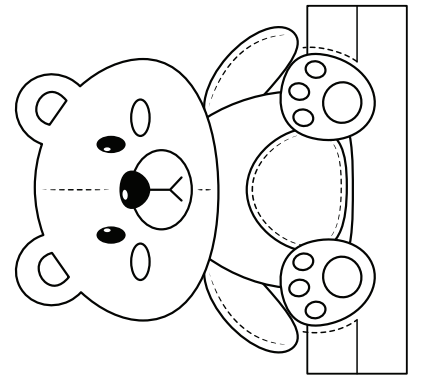
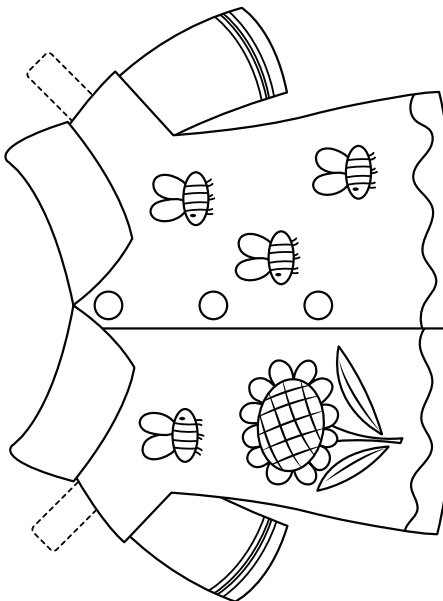
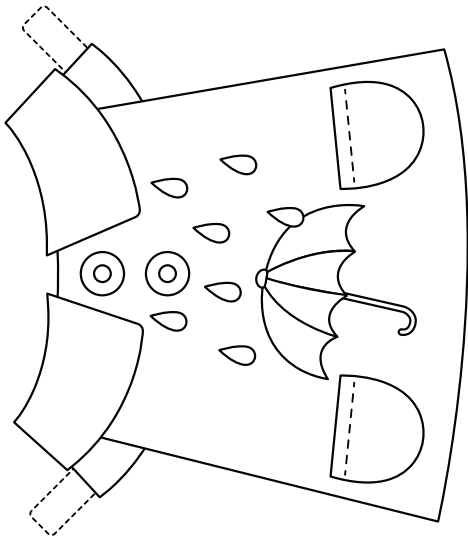
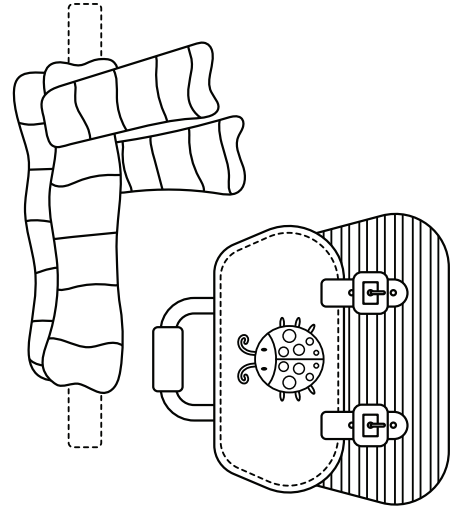
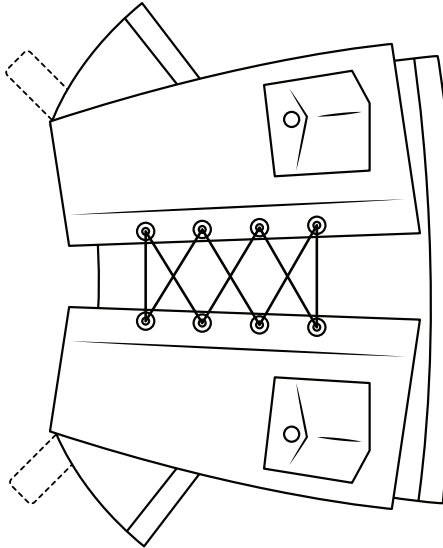
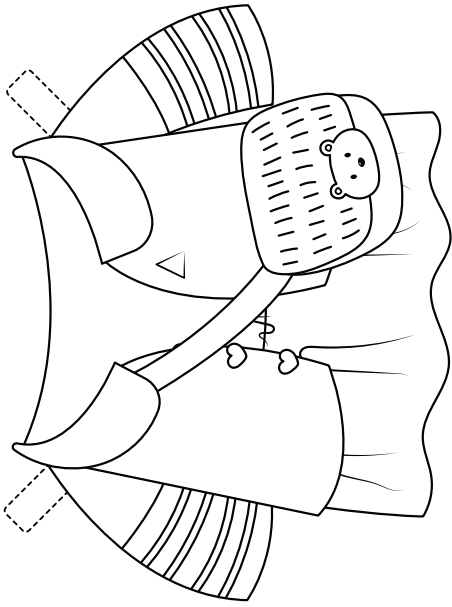
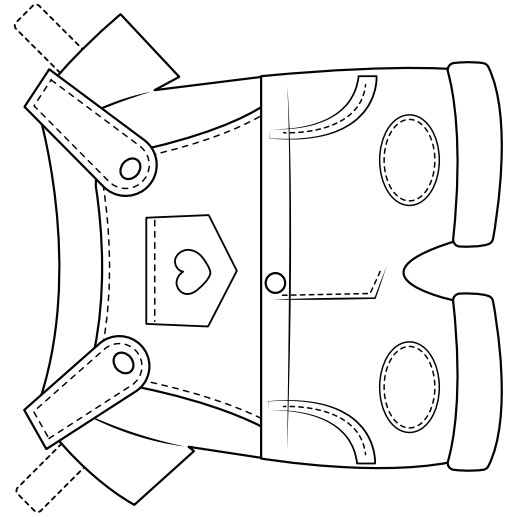
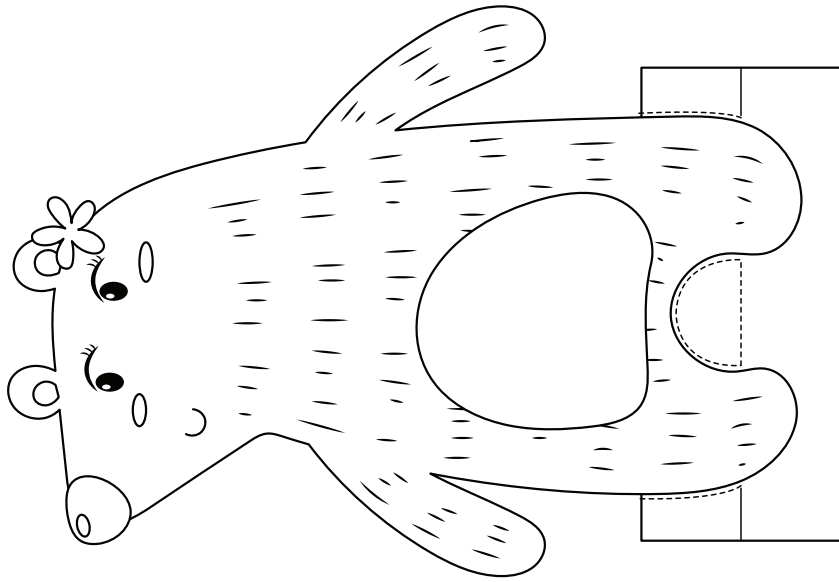

Cut & Glue!
Play

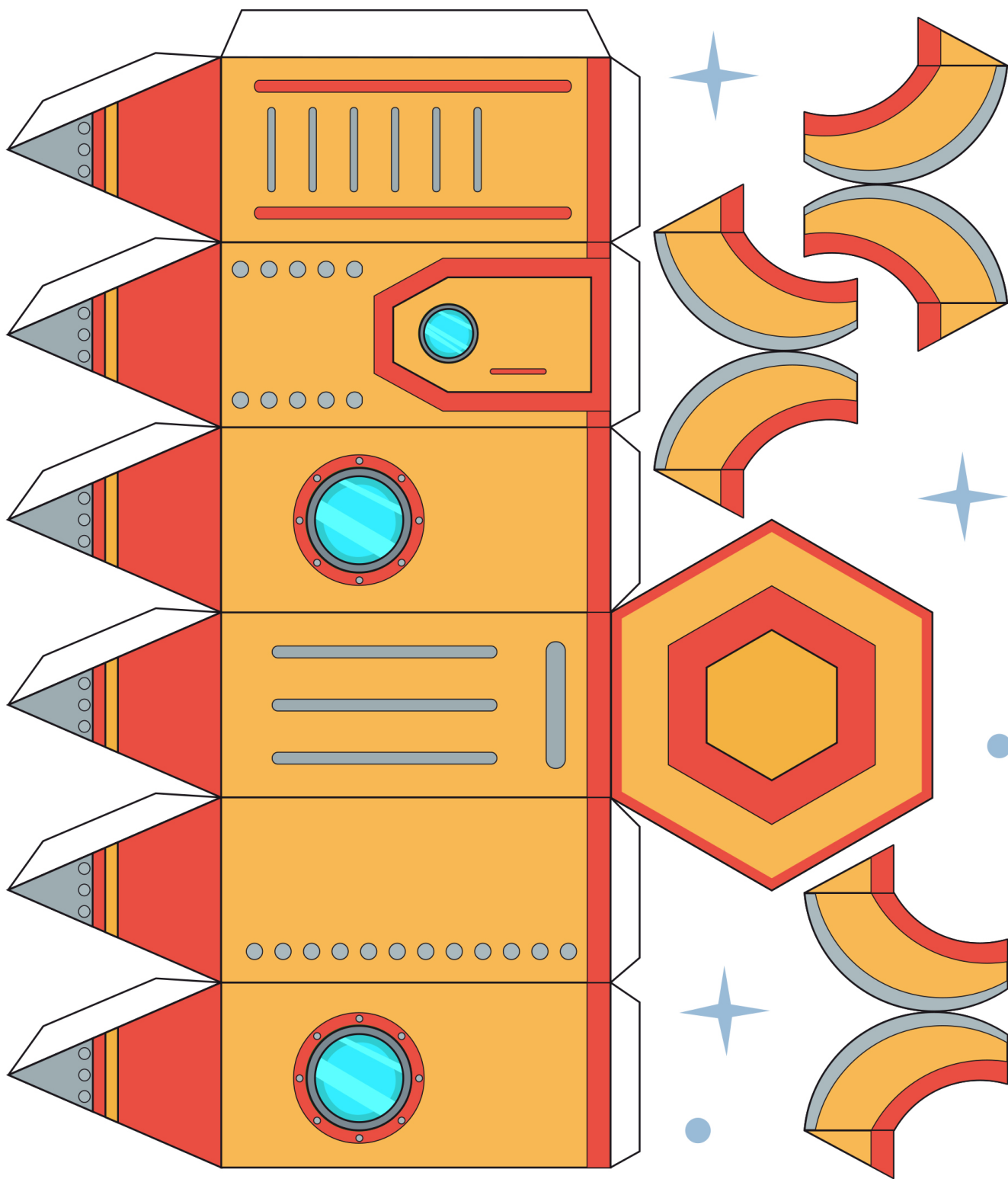
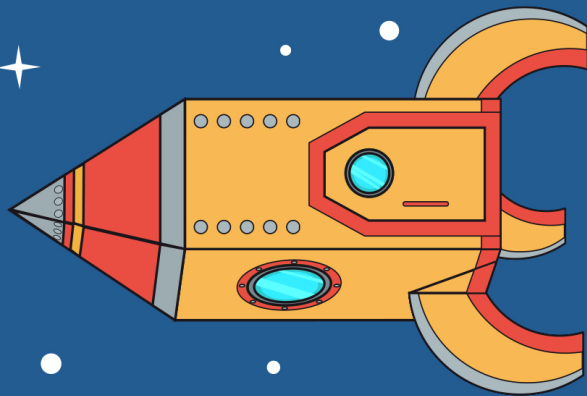

HOW TO DRAW A BUNNY

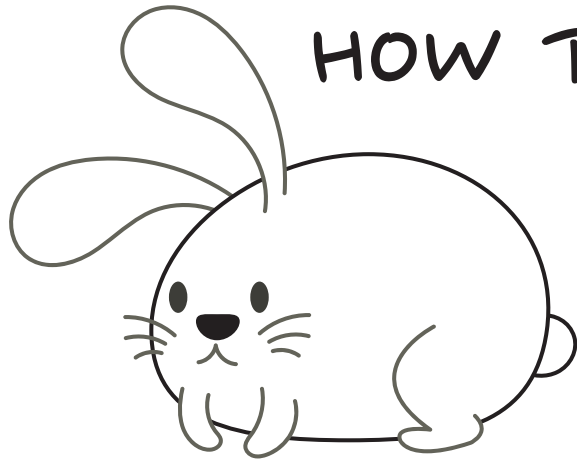

1.

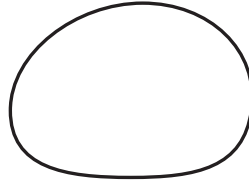

2.

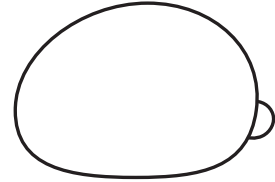

3.

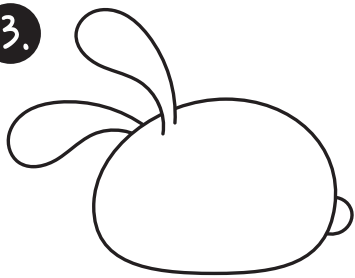

4.

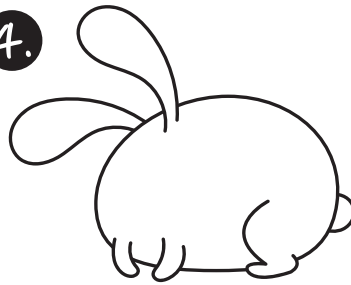

5.

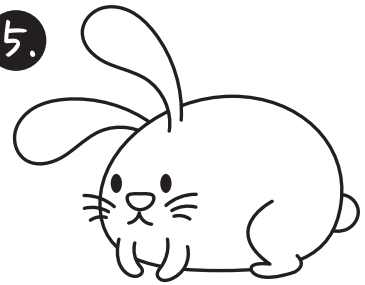

HOW TO DRAW A SPIDER

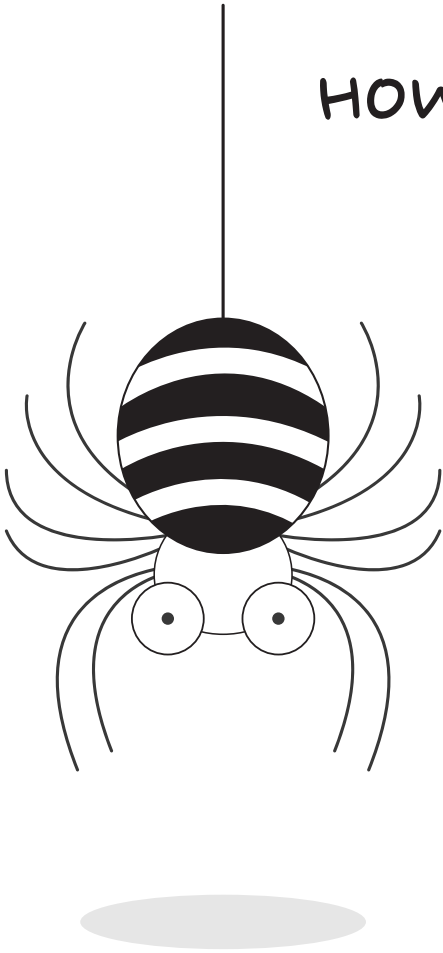

1. BODY

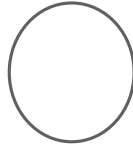

2. HEAD

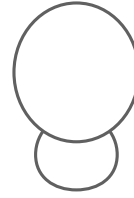

3. EYES

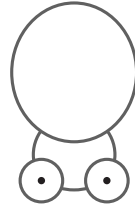

4. LEGS

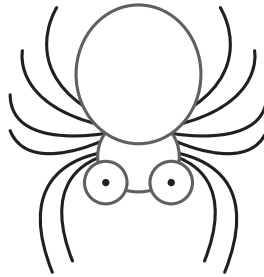

5. DETAILS



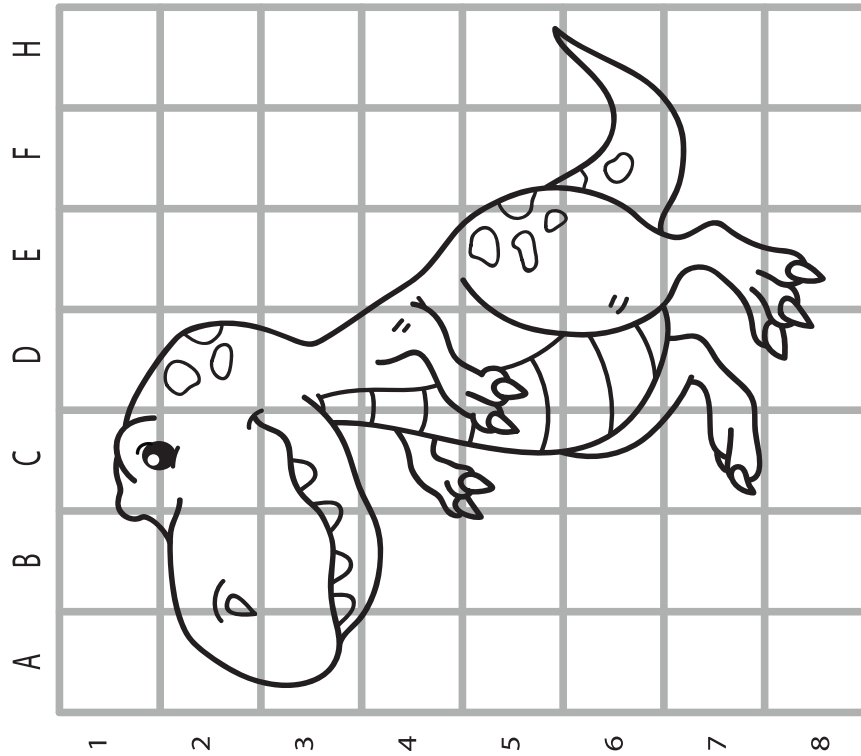
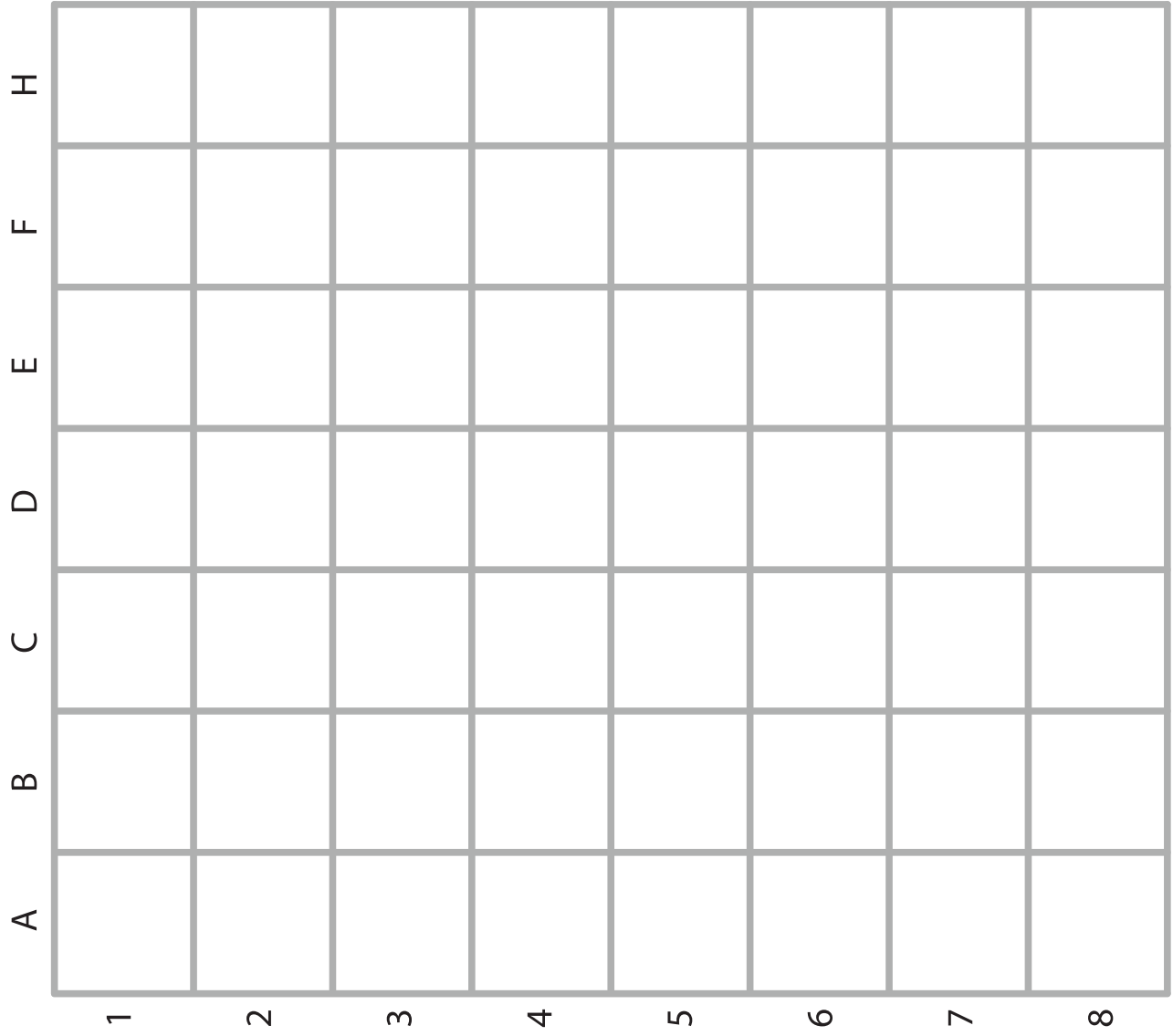

Copy the picture
using the grid

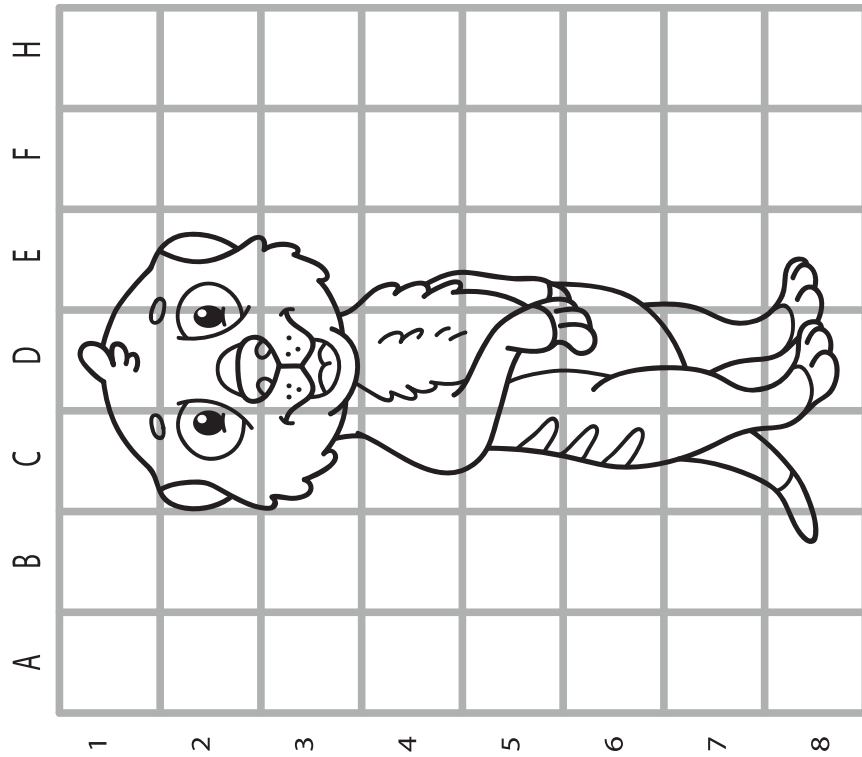
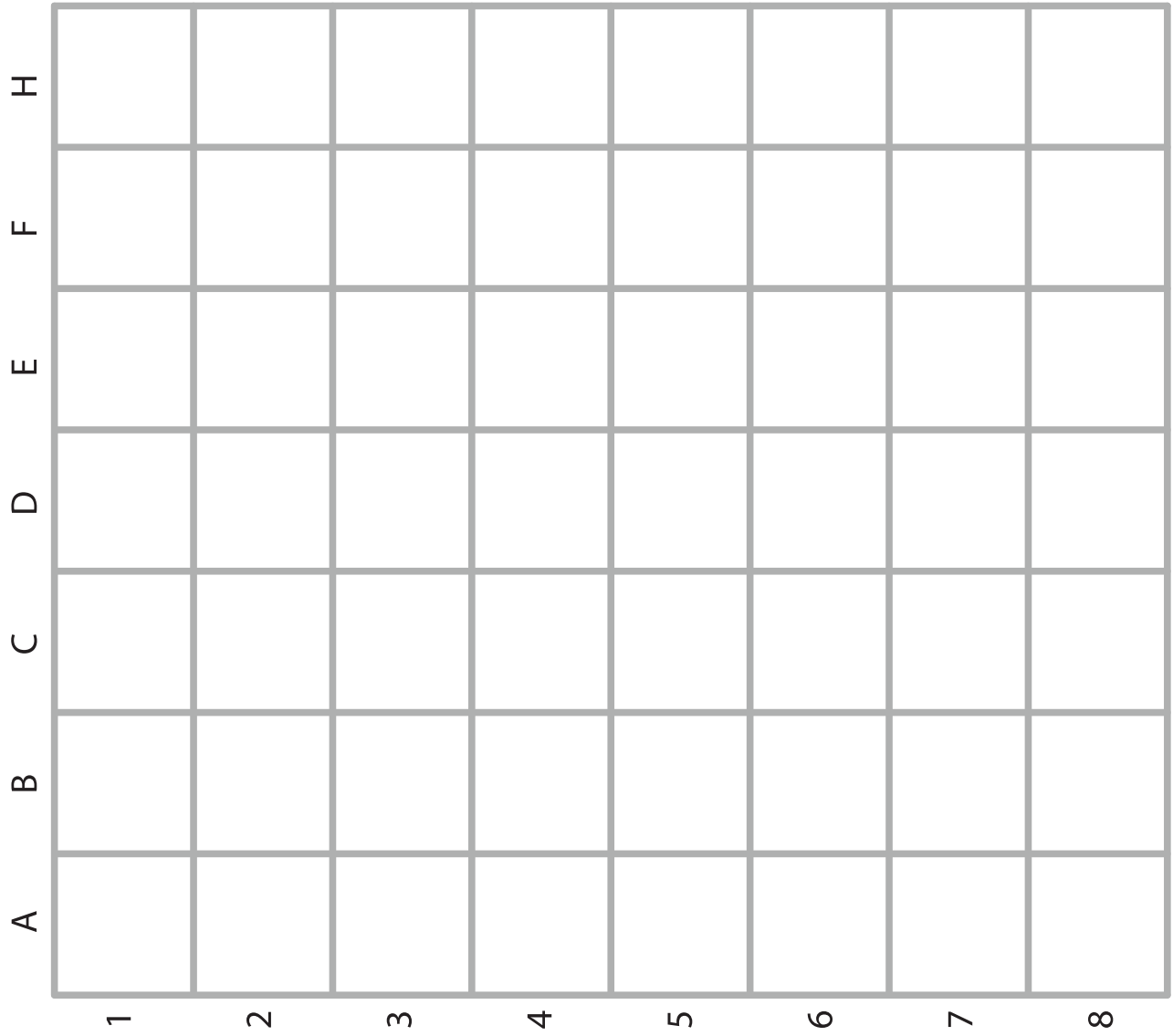

Copy the picture
using the grid



Flower

Ant

Puddle

Cloud

Bee

Spider web

Butterfly

Worm

Squirrel

Bird

Grass

Feather

Ladybug

Leaf

Pine cone

Nature Word Search

L	A	H	E	T	O	J	P	K	W
I	C	R	E	S	C	E	N	T	I
F	R	I	D	S	Y	R	I	C	N
C	L	O	U	D	S	A	M	J	D
T	I	Y	K	G	Y	I	E	T	A
A	L	I	G	H	T	N	I	N	G
S	H	A	S	I	L	B	H	T	I
N	E	F	O	G	K	O	E	S	D
O	R	A	I	N	A	W	E	U	S
W	Y	S	T	A	R	A	L	N	Y

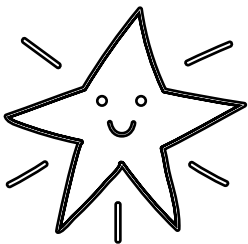
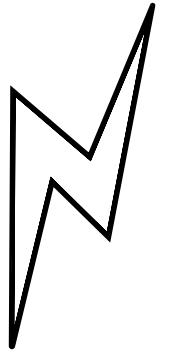
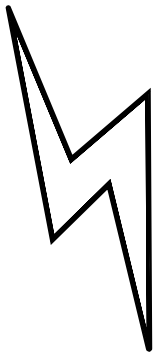

snow
fog
rain
star
sun

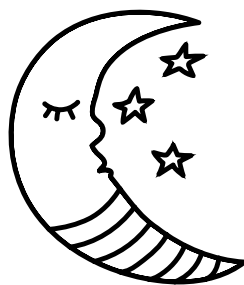

lightning
rainbow
wind
crescent
clouds

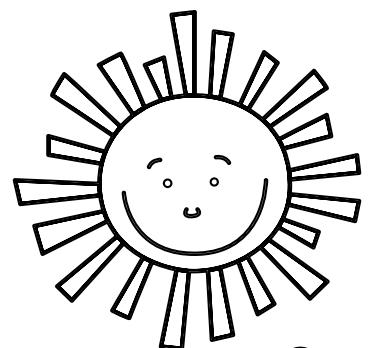
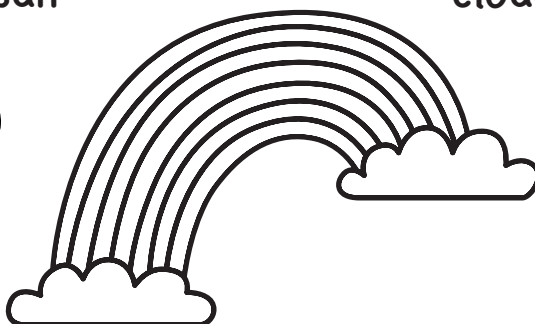
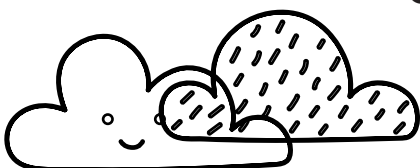
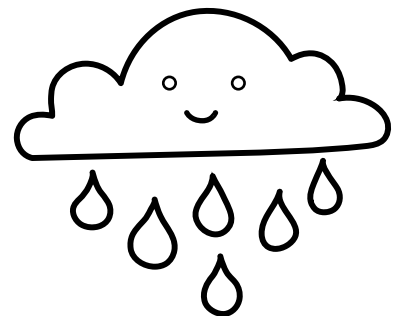

Sports Word Search

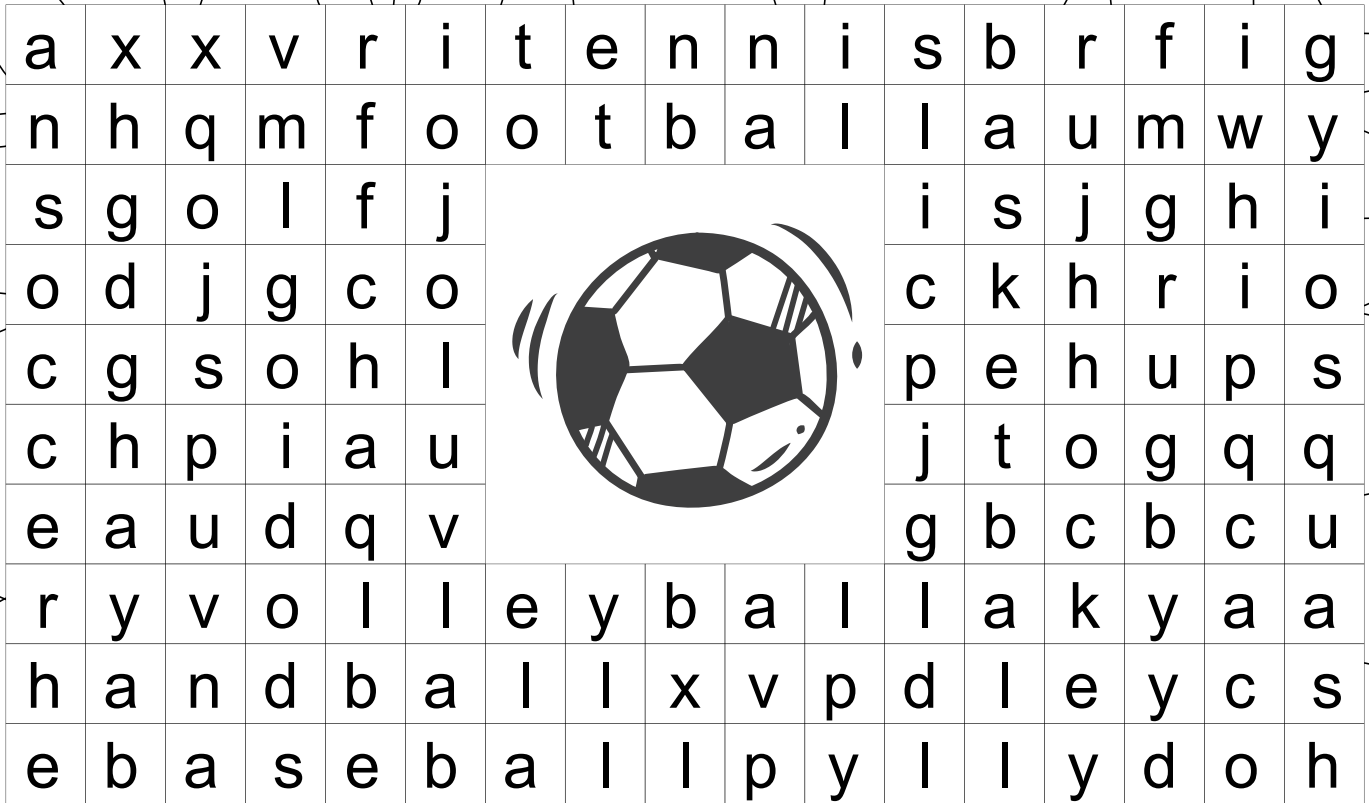

baseball

handball

squash

basketball

hockey

tennis

football

rugby

volleyball

golf

soccer

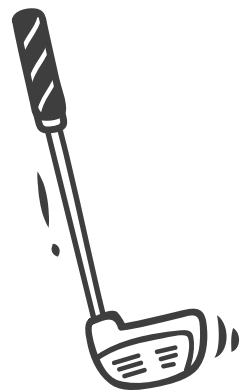
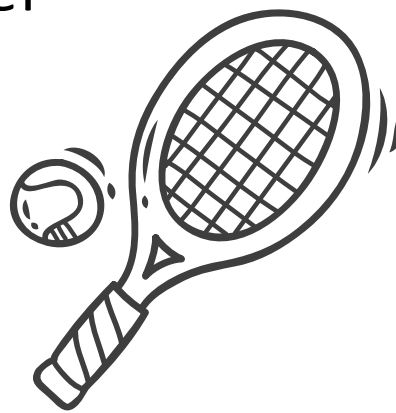
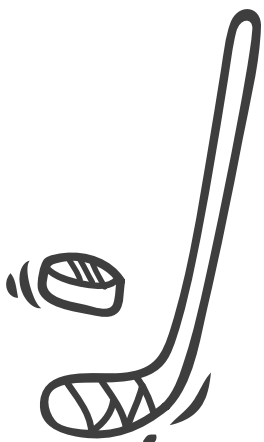

FIND THE WORDS

T Y P I S T A R T I S T
R U N E D I T O R K C R
A V R U I K B P Z D H A
N T W N R E A O C R E I
S E E E S K E A I M N
L A L M C R E T R V I E
A C D C T I R E P E S R
T H E H O N N W E R T J
O E R E R A T A N N N B
R R U F E H U I T A C U
S P I L O T T T E N O Y
D O C X V V O E R N O E
F L A W Y E R R M Y K R

ARTIST	DIRECTOR	TRAINER
BAKER	DRIVER	TRANSLATOR
BUYER	EDITOR	TURNER
CARPENTER	LAWYER	TUTOR
CHEF	NANNY	TYPIST
CHEMIST	NURSE	WAITER
CLEANER	PILOT	WELDER
CLERK	POET	
COOK	TEACHER	

Help the dino mom find her baby!

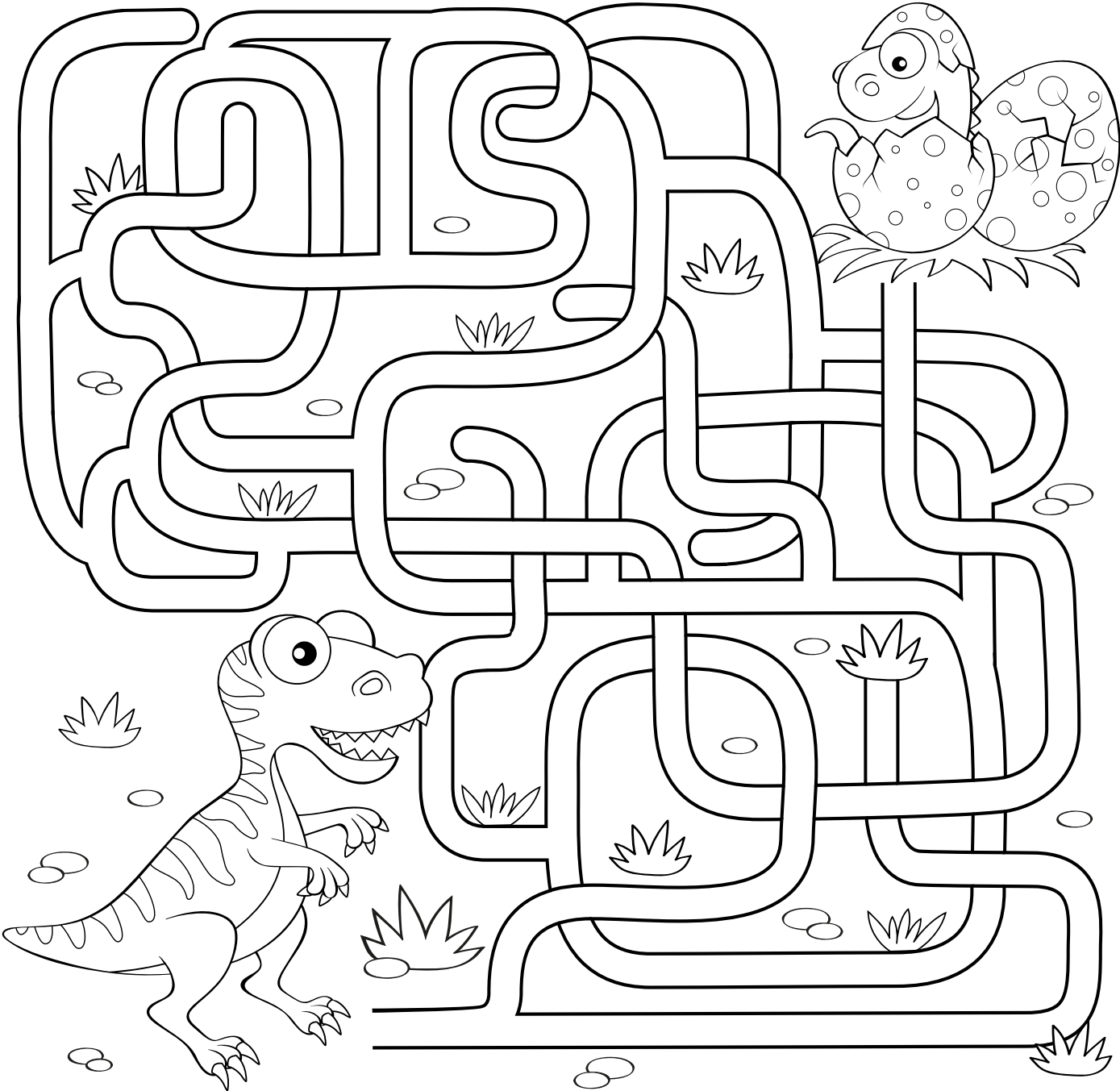

Start here

FIND THE RIGHT PATH

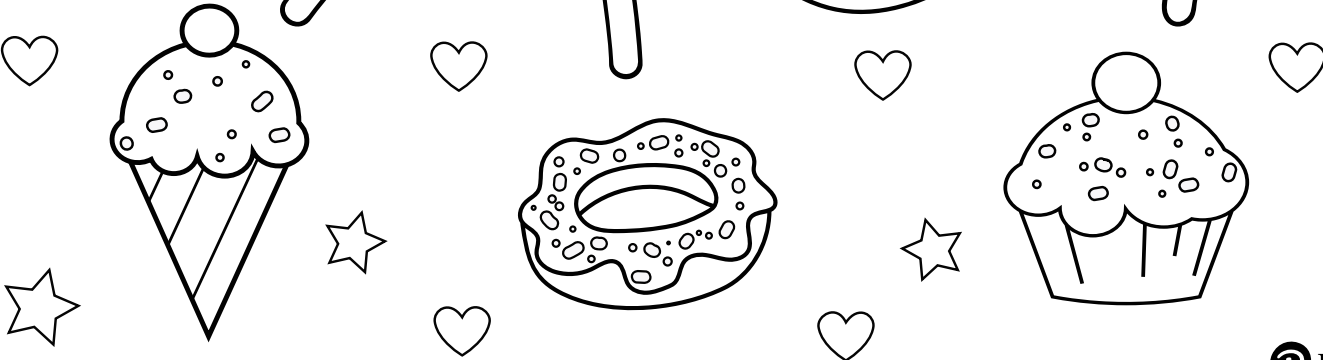
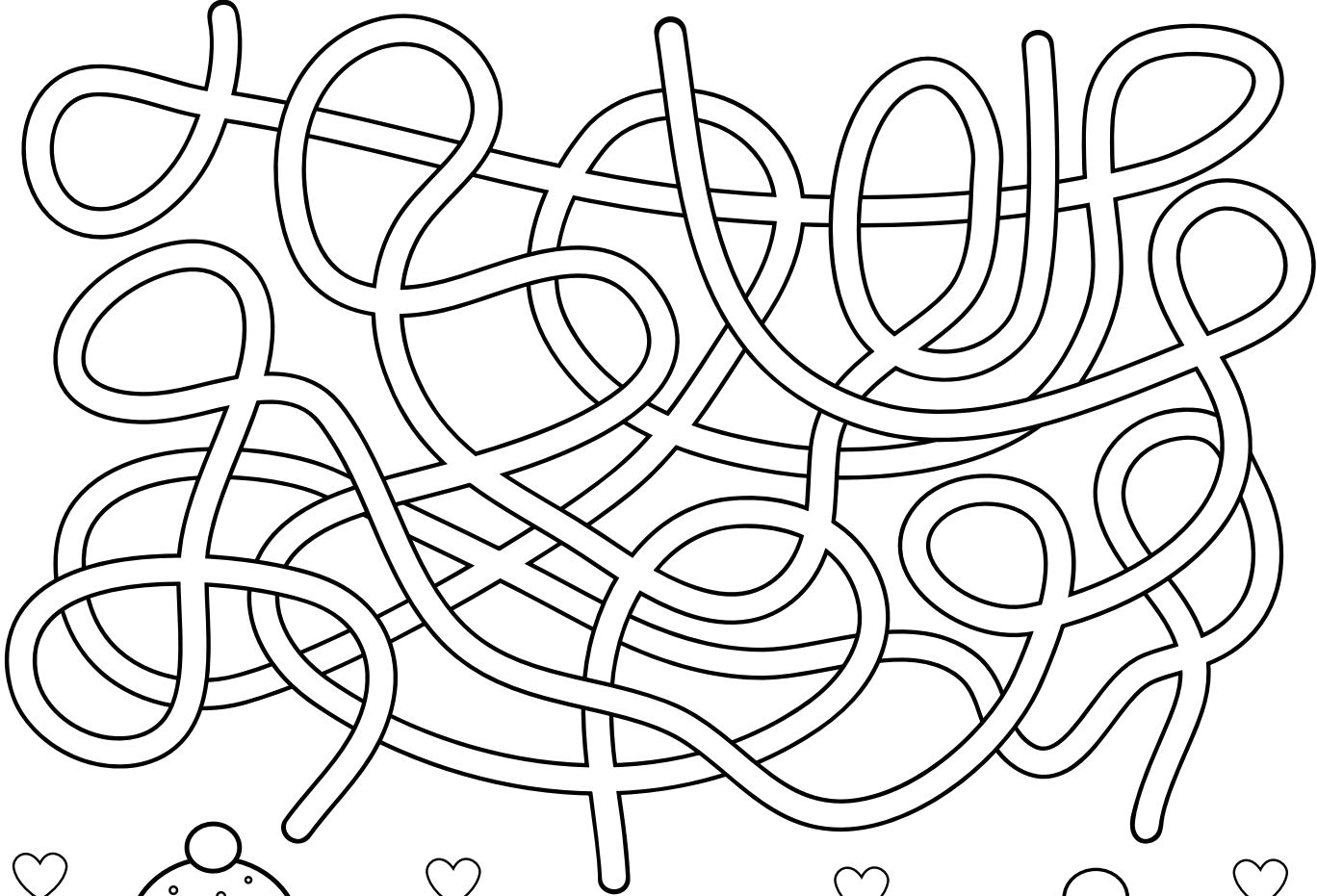
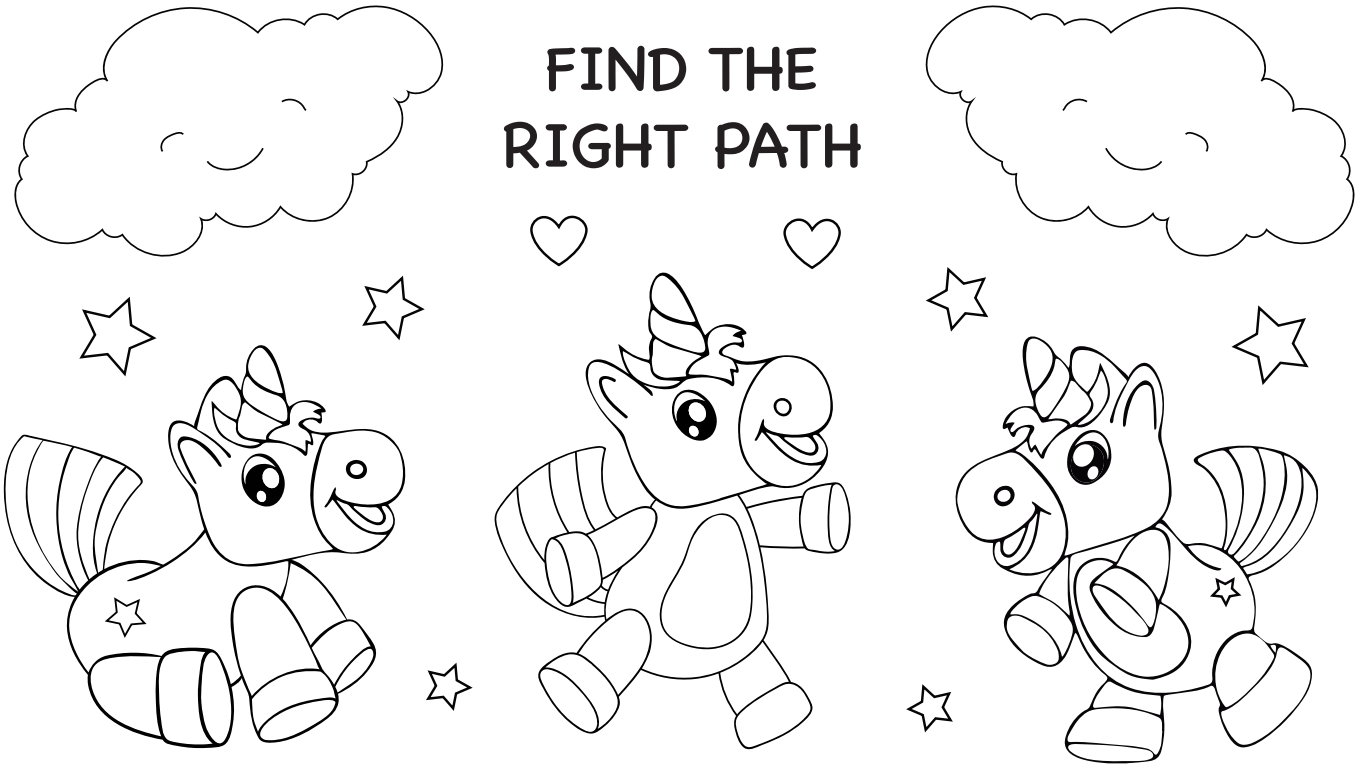

HELP THE ROCKET SHIP REACH THE MOON!

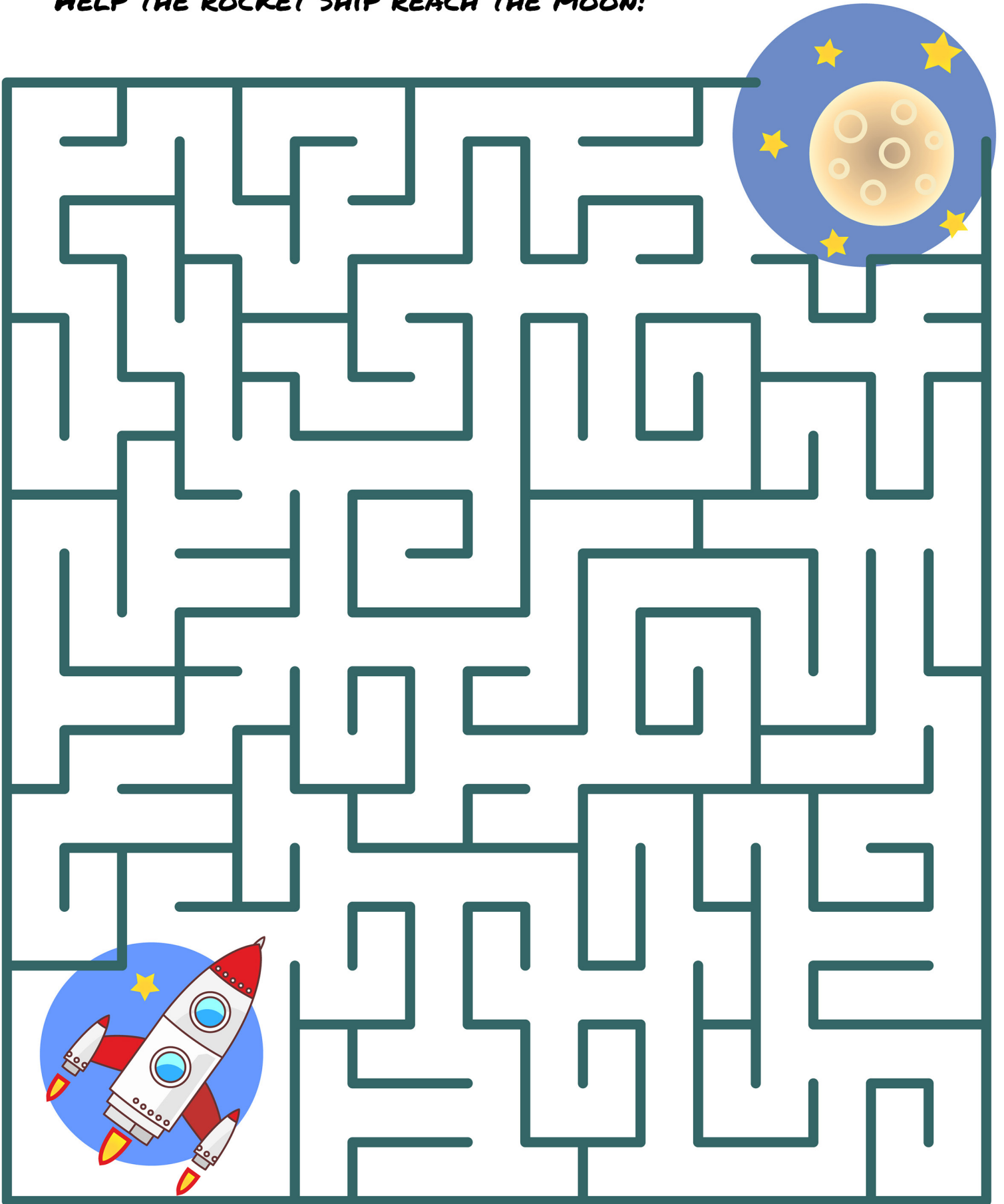

CONNECT THE DOTS!

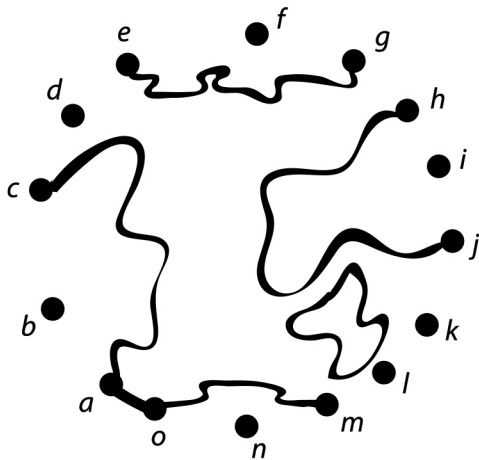
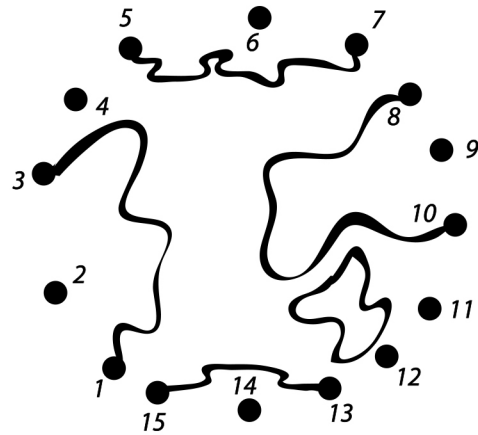
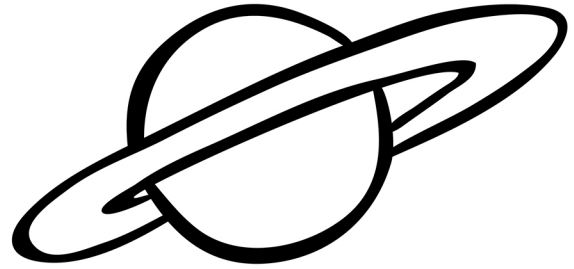
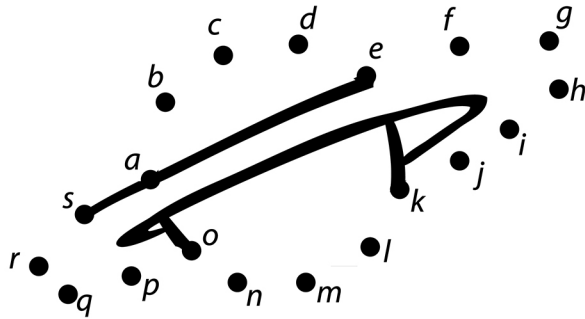
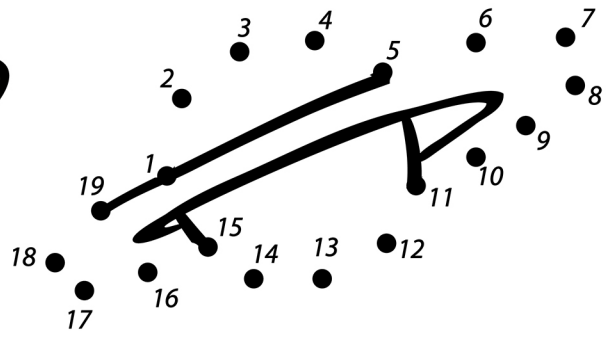
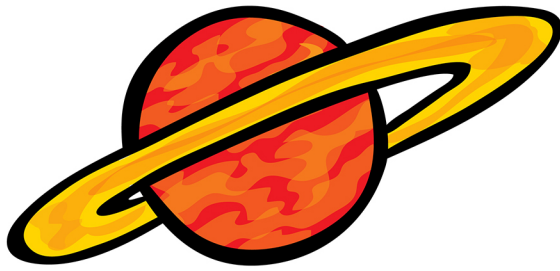

.....
Connect the dots
.....

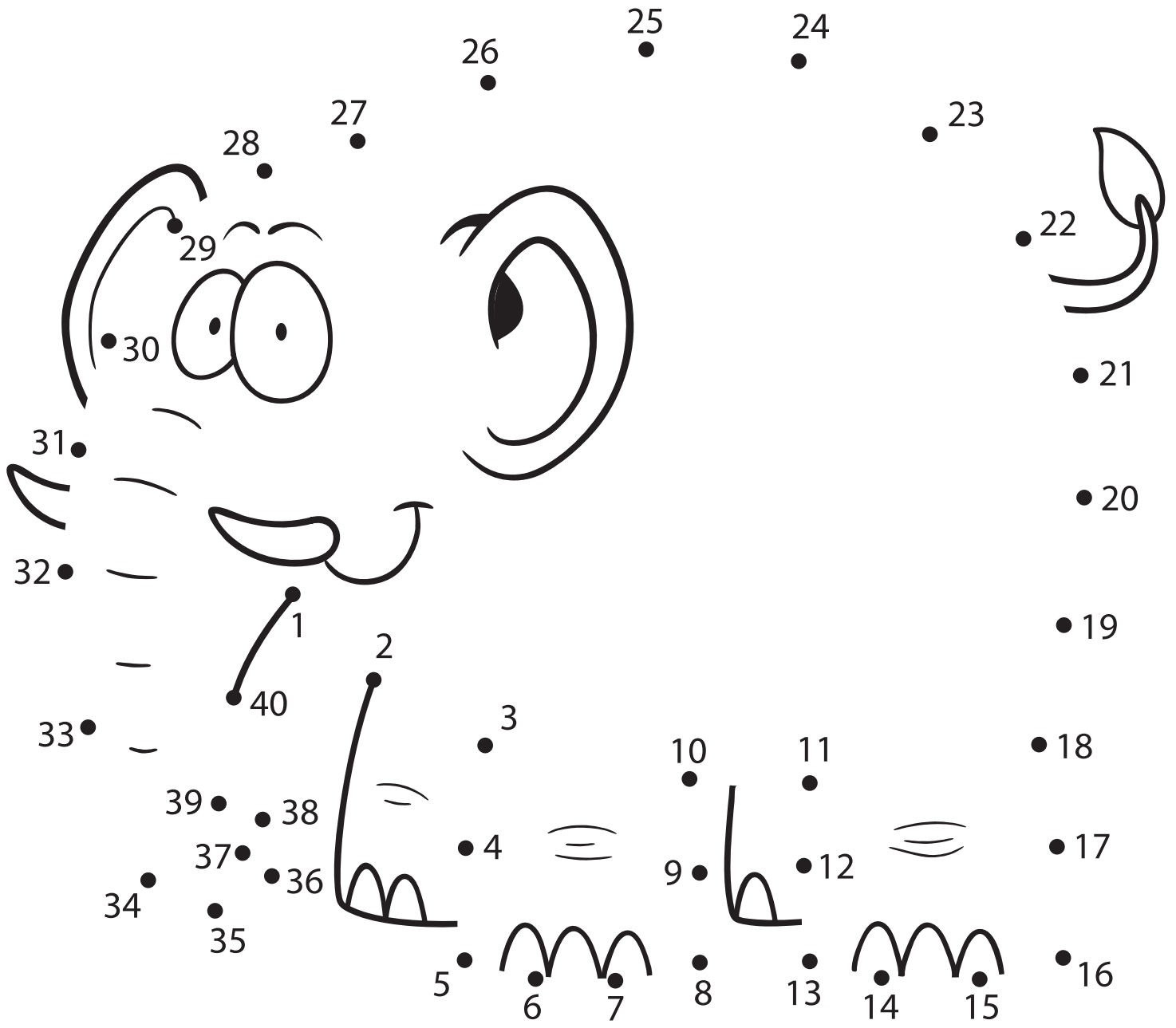

.....
Connect the dots
.....

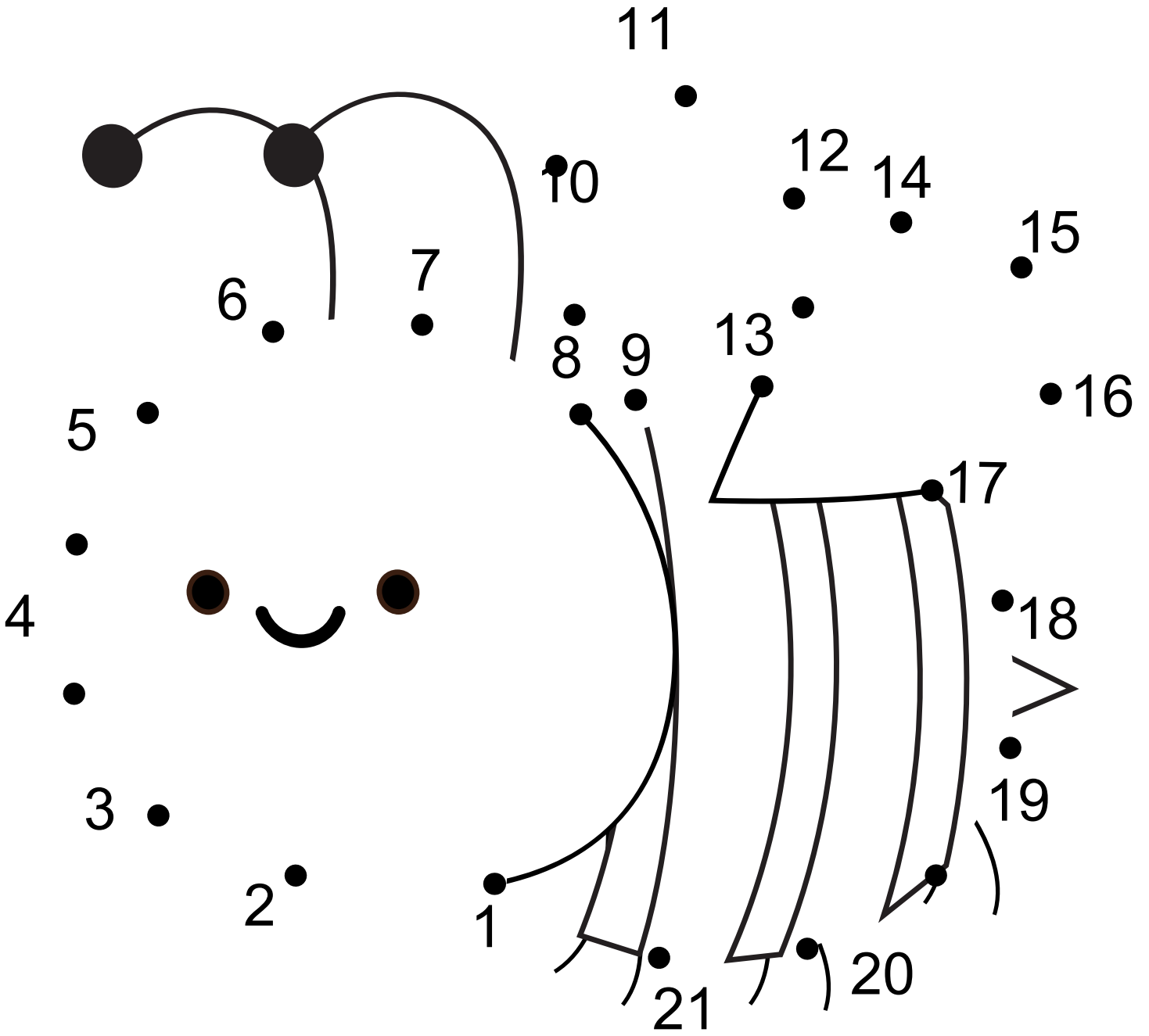

Connect the dots



Connect the dots

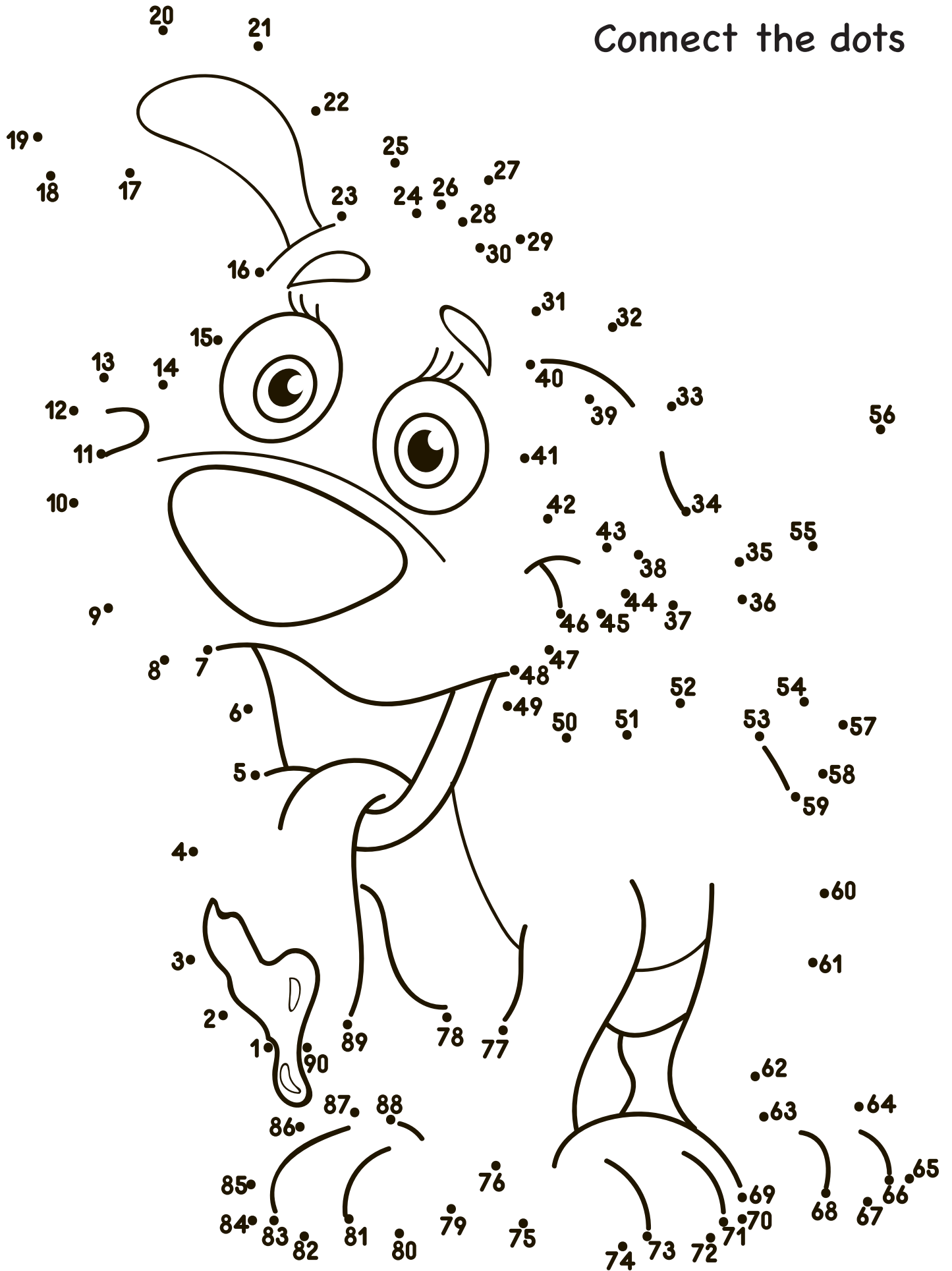

Thank You



 PearsonAssessments

Designs by Liz, Mike, Michael & Senta